

**RIELLO**  
**B**  
**BURNERS**

CE

## ONE STAGE LIGHT OIL BURNERS

▶ RIELLO 40 F SERIES

▶ F5	30 ÷ 60 kW
▶ F10	54 ÷ 107 kW
▶ F20	95 ÷ 202 kW



The Riello 40 F series of one stage light oil burners, is a complete range of products developed to respond to any request for light industrial applications. The Riello 40 F series is available in three different models, with an output ranging from 30 to 202 kW, divided in three different structures.

All the models use the same components designed by Riello for the Riello 40 F series. The high quality level guarantees safe working.

In developing these burners, special attention was paid to reducing noise, to the ease of installation and adjustment, to obtaining the smallest size possible to fit into any sort of boiler available on the market.

All the models are approved by the EN 267 European Standard and conform to European Directives for EMC, Low Voltage, Machinery and Boiler Efficiency.

All the Riello 40 F burners are fired before leaving the factory.



# TECHNICAL DATA

Model		▼ F5	▼ F10	▼ F20
<b>Setting</b>		One stage		
Servo-motor	type	--		
	run time	s		
Heat output	kW	30 - 60	54 - 107	95 - 202
	Mcal/h	25,8 - 51,6	46,4 - 92	81,7 - 173,7
	kg/h	2,5 - 5	4,5 - 9	8 - 17
Working temperature	°C min./max.	0/40		
Net calorific value	kWh/kg	11,8		
	kcal/kg	10.200		
Viscosity at 20°C	mm <sup>2</sup> /s (cSt)	4 ÷ 6		
Pump	type	R.B.L.		
	output	kg/h at 12 bar		
Atomised pressure	bar	7 - 15		
Fuel temperature	max. °C	50		
Fuel pre-heater		NO	NO	NO
Fan	type	forward tilted blades		
Air temperature	max. °C	40		
Electrical supply	Ph/Hz/V	1/50/230 ±10%		
Aux. electrical supply	Ph/Hz/V	--		
Control box	type	530 SE		
Total electrical power	kW	0,13	0,17	0,33
Total rated current	A	0,75	0,85	1,5
Protection level	IP	40		
Motor electrical power	kW	0,1	0,14	0,30
Rated motor current	A	0,75	0,85	1,5
Motor start current	A	3	3,5	6
Motor protection level	IP	20		
Ignition transformer		incorporated in the control box		
Operation		intermittent (at least one halt every 24 h)		
Sound pressure	dB(A)	60	66	73
CO Emissions	mg/kWh	<60		
Grade of smoke indicator	N° Bach.	<1		
C <sub>x</sub> H <sub>y</sub> Emissions	mg/kWh	<10 AFTER THE FIRST 20s		
NO <sub>x</sub> Emissions	mg/kWh	<250		
Directives		89/336/EEC, 73/23/EEC, 98/37/EEC, 92/42/EEC		
Conforming to		EN 267		
Certifications		--	--	--

Reference conditions:

Temperature: 20 °C

Pressure: 1013.5 mbar

Altitude: 100 m a.s.l.

Noise was measured in the boiler room behind the burner at a distance of 1 meter.

Since the Company is constantly engaged in the production improvement, the aesthetic and dimensional features, the technical data, the equipment and the accessories can be changed.  
This document contains confidential and proprietary information of RIELLO S.p.A. Unless authorised, this information shall not be divulged, nor duplicated in whole or in part.



# FIRING RATES

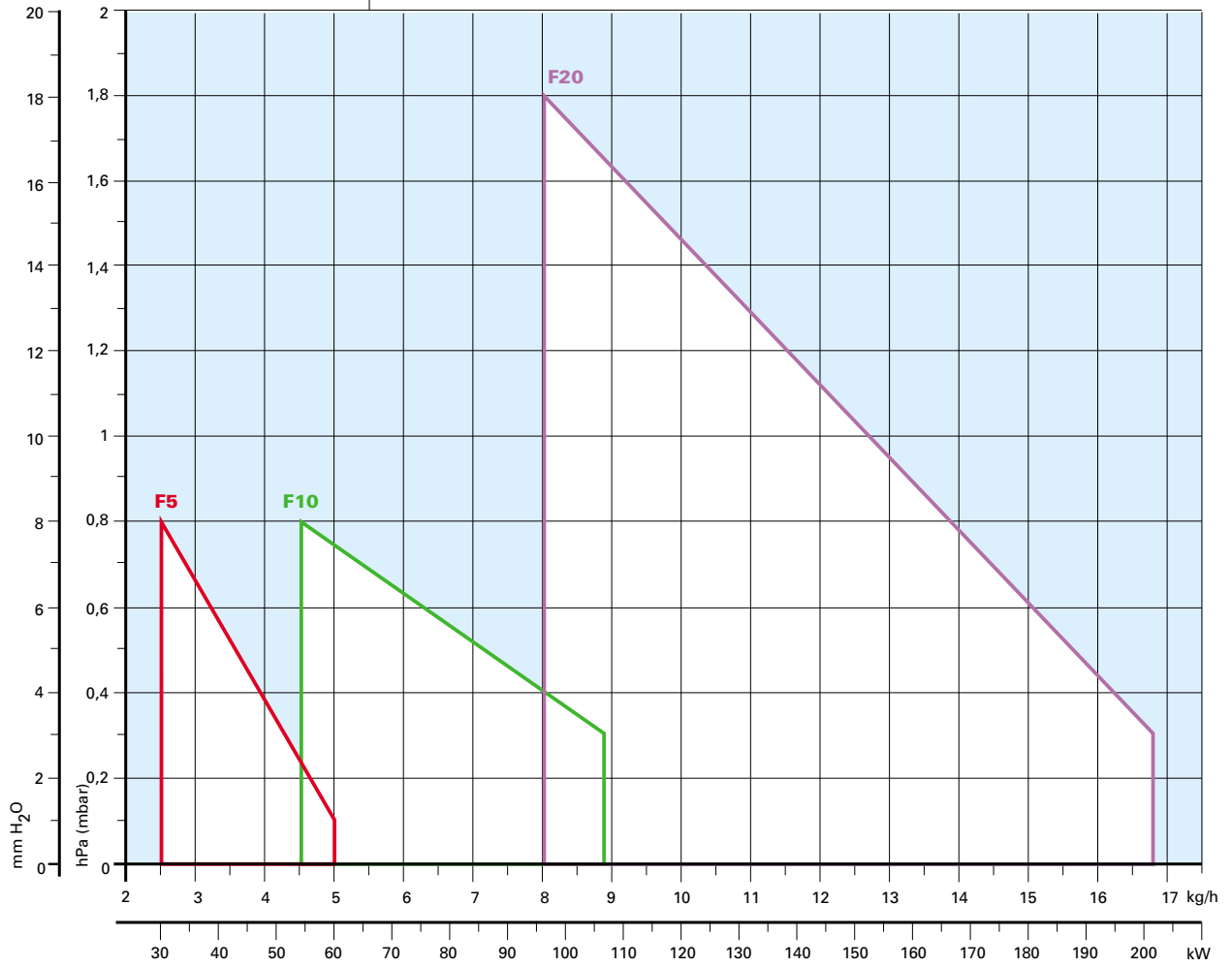

Useful working field for choosing the burner

**Test conditions conforming to EN 267 standards:**  
Temperature: 20°C  
Pressure: 1013.5 mbar  
Altitude: 100 m a.s.l.



## FUEL SUPPLY

### HYDRAULIC CIRCUITS

All the burners have a R.B.L. geared pump with safety valve on the return circuit.

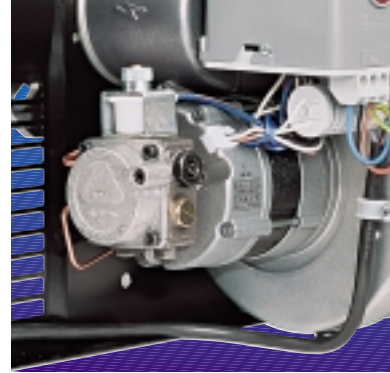

Fuel pump

F5 - F10 - F20

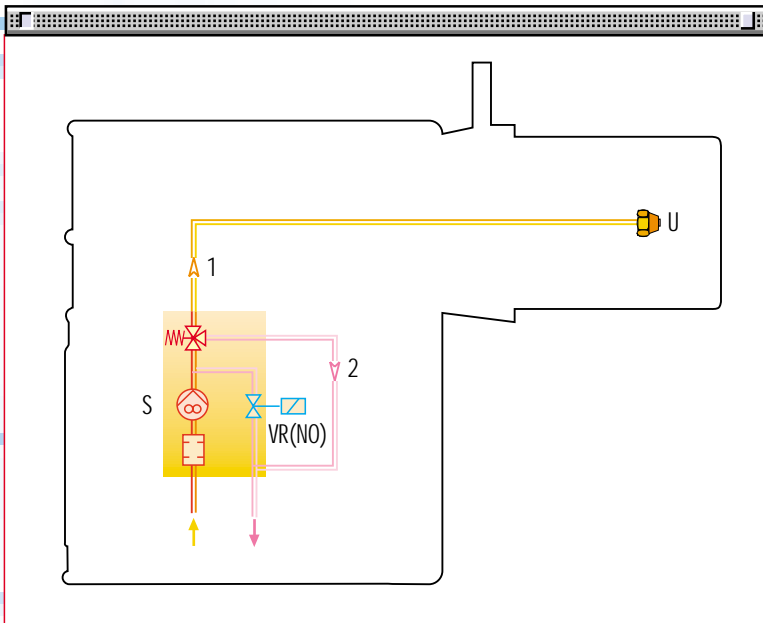

S	Pump with filter and pressure regulator on the delivery pipe
VR(NO)	Oil return valve on the delivery pipe
1	Oil input pipe to the nozzle
2	Oil return pipe from the regulator
U	Nozzle

Fuel feed to the burner can be from the right or the left side on all models.



## DIMENSIONING OF THE FUEL SUPPLY LINES

The fuel feed must be completed with the safety devices required by the local regulations in force.

The table shows the choice of piping diameter for the various burners, depending on the difference in the height between the burner and the tank and the distance between them.

MAXIMUM EQUIVALENT LENGTH OF THE PIPEWORK L[m]				
Pipe size	▼ Type A system		▼ Type B system	
	Ø8mm	Ø10mm	Ø8mm	Ø10mm
H (m)	L <sub>max</sub> (m)	L <sub>max</sub> (m)	L <sub>max</sub> (m)	L <sub>max</sub> (m)
0	35	100	-	-
0,5	30	100	10	20
1,0	25	100	20	40
1,5	20	90	40	80
2,0	15	70	60	100
3,0	8	30	-	-
3,5	6	20	-	-

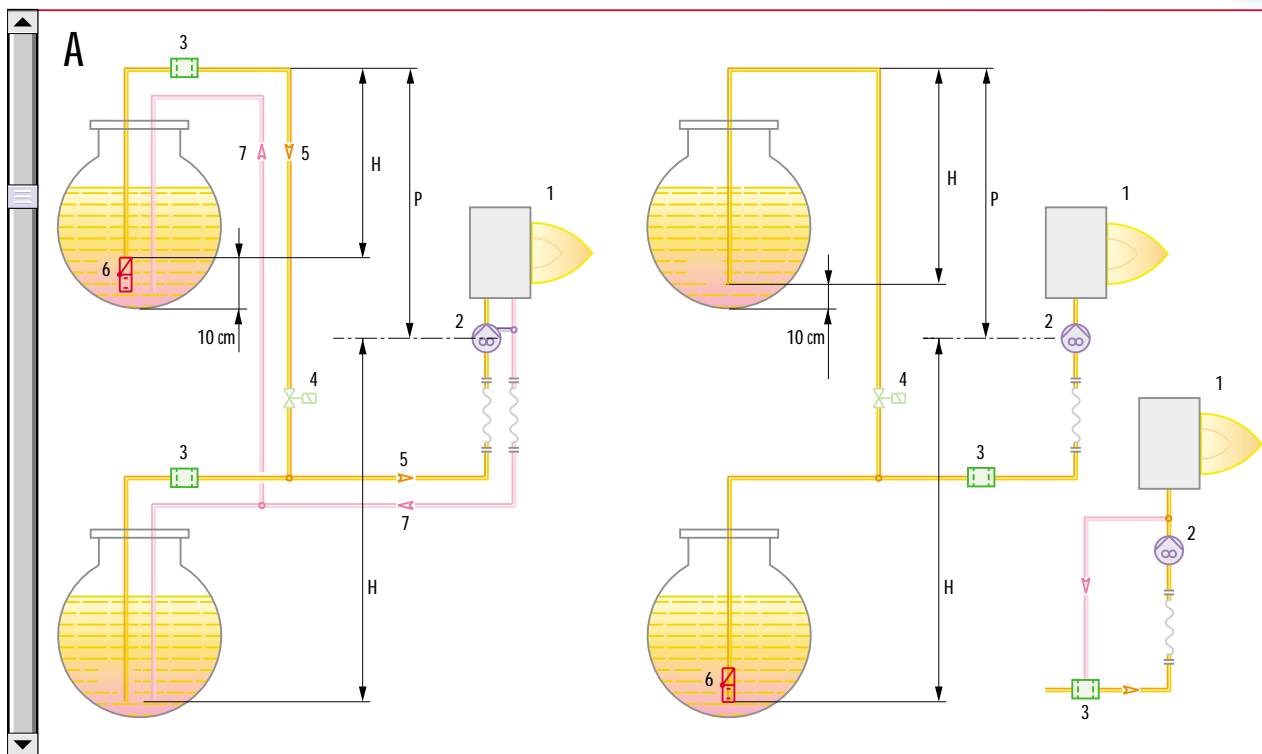

### Type of system that can be installed

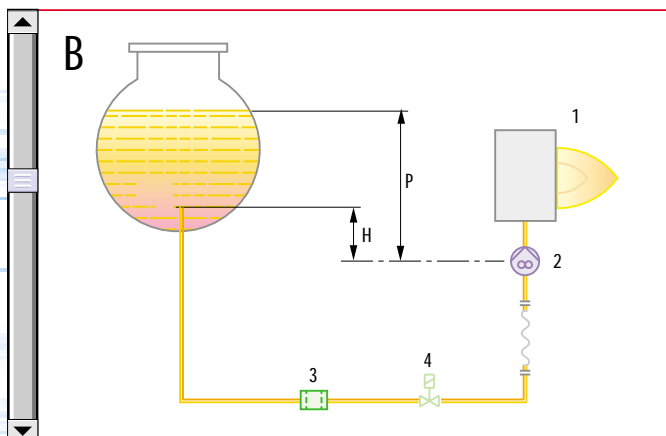

H	Difference in height
Ø	Internal pipe diameter
P	Difference in height ≤ 4 m
1	Burner
2	Pump
3	Filter
4	Shut-off solenoid valve
5	Suction pipework
6	Bottom valve
7	Return pipework



## VENTILATION

The ventilation circuits always ensure low noise levels with high performance of pressure and air delivery, inspite of their compact size.



Air suction



## COMBUSTION HEAD

All the models have adjustable combustion heads.

Simple adjustment to the combustion head allows adapting internal geometry of the head to the maximum rated output of the burner.



Combustion head

### Combustion chamber dimensions used in the test laboratory

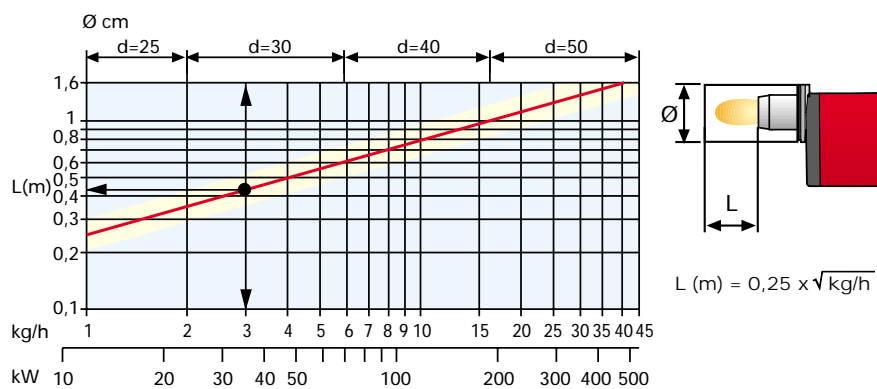

With simple adjustments, the burner can be adapted to combustion chambers that are slightly different from those used in the tests.

Example:  
burnt thermal delivery = 3 kg/h;  
 $L(m) = 0,25 \times \sqrt{3} = 0,43$  (m);  
 $\text{Ø} = 30$  (cm)

# ADJUSTMENT



## BURNER OPERATION MODE

All these models are one stage operation.



Air damper

### One stage operation

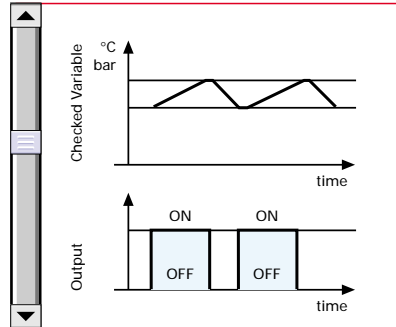

## IGNITION

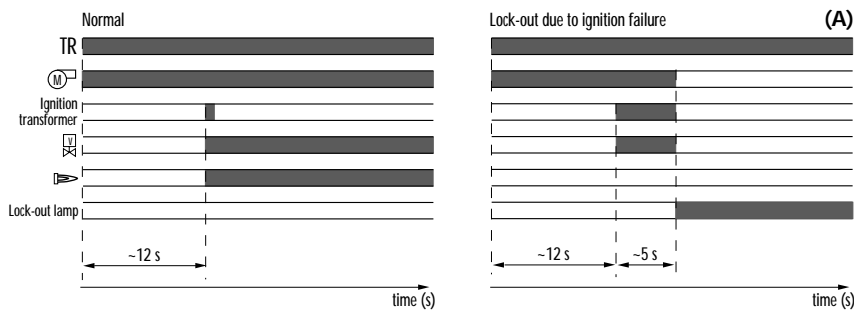

(A) Lock-out is shown by a led on the appliance.

Correct operation

- 0s The burner begins the ignition cycle.
- 0s-12s Pre-purge with the air damper open.
- 12s Ignition.

Lock-out due to ignition failure

If the flame does not light within the safety limit (~ 5s) the burner locks-out.





## ELECTRICAL CONNECTIONS *to be made by the installer*

Electrical connections must be made by qualified and skilled personnel in conformity with the local regulations in force.



Control box fitted with an ignition transformer

### ▶ "ONE STAGE" OPERATION

#### F5 - F10 - F20

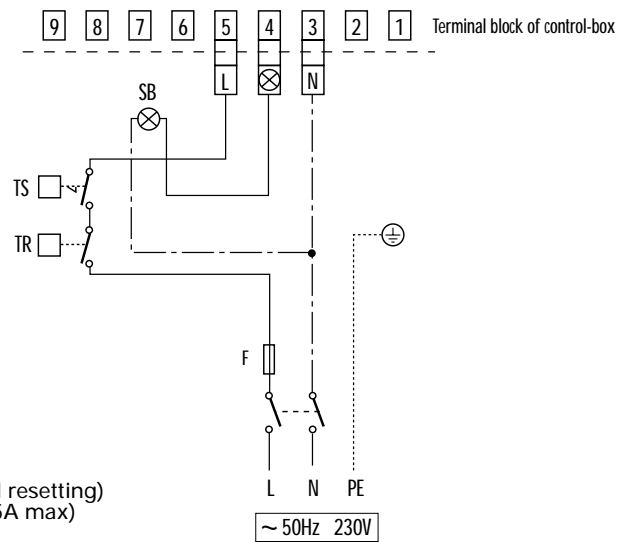

TR - Regulating thermostat  
 TS - Safety thermostat (with manual resetting)  
 SB - Remote lock-out lamp (230V 0,5A max)  
 F - Fuse

The following table shows the supply lead sections and types of fuse to be used.

Model	▼ F5	▼ F10	▼ F20
	230V	230V	230V
F A	6	6	T6
L mm <sup>2</sup>	1	1	1

F = Fuse      L = Lead section



# EMISSIONS

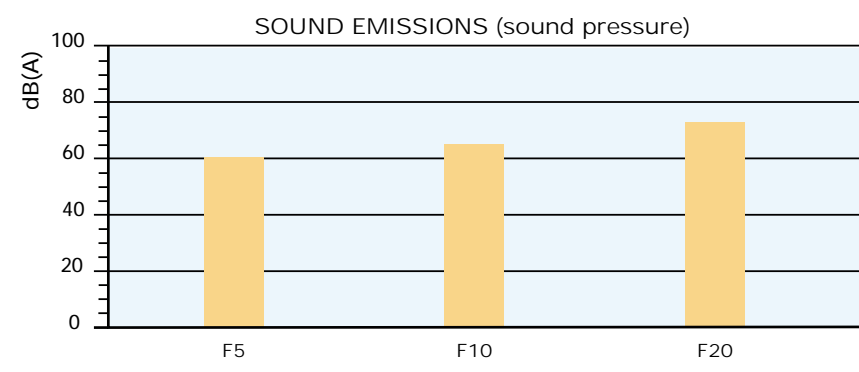
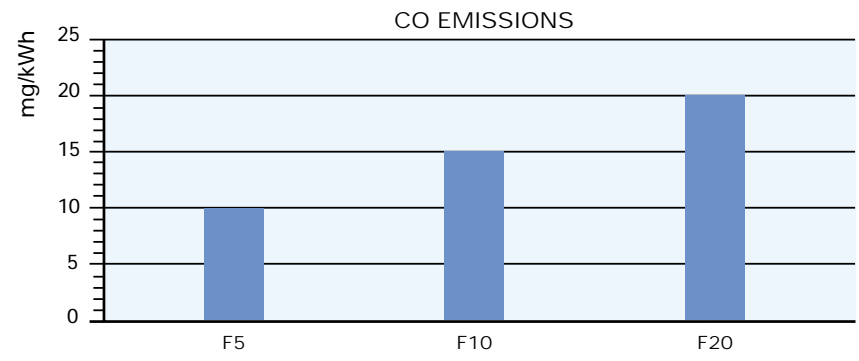
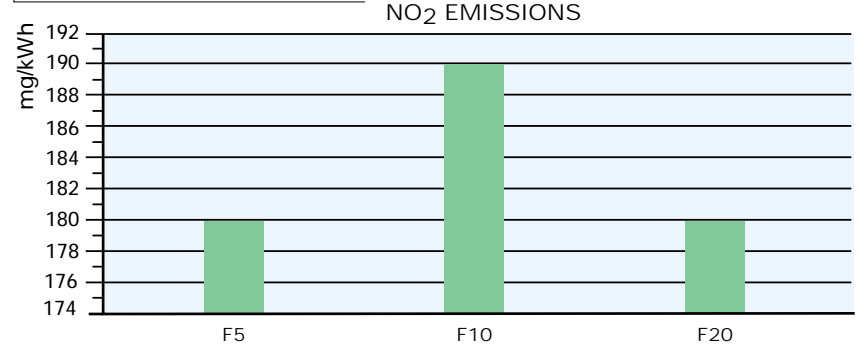

The emission data have been measured in the various models at maximum output, in conformity with EN 267 standard.





## OVERALL DIMENSIONS (mm)

These models are distinguished by their reduced size, in relation to their outputs, which means they can be fitted to any boiler on the market.

### BURNERS

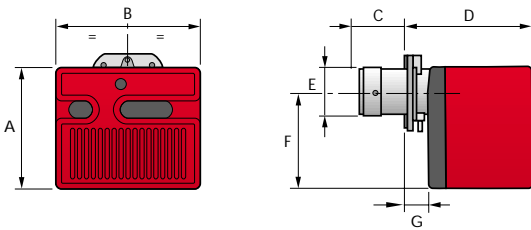

Model	A	B	C	D	E	F	G
► F5	233	272	76	240	89	180	41
► F10	262	305	108	265	105	204	44
► F20	298	350	118	299	125	230	45

### BURNER-BOILER MOUNTING FLANGE

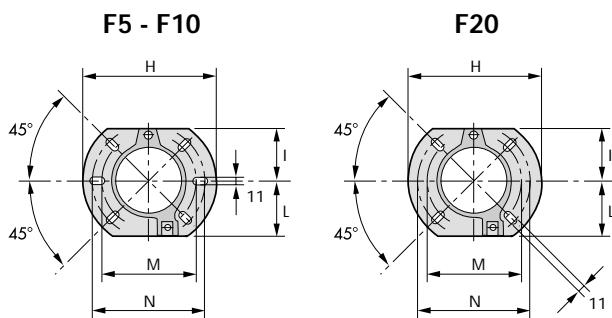

Model	H	I	L	M	N
► F5	180	72	75	130	150
► F10	189	83	83	140	170
► F20	213	99	99	160	190

### PACKAGING

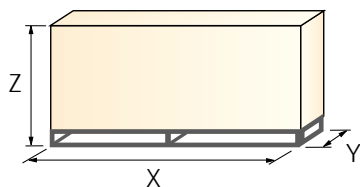

Model	X	Y	Z	kg
► F5	373	305	315	11
► F10	413	338	330	12
► F20	473	383	367	15

## INSTALLATION DESCRIPTION

Skilled and qualified personnel must perform installation, start up and maintenance. A nozzle is fitted to the burner and used for fire tests in the factory. If necessary, change the nozzle on the basis of the maximum output of the boiler.

All operations must be carried in accordance with the technical handbook supplied with the burner.



### BURNER SETTINGS

- ▶ Air damper and head adjustment area are easily accessible and the operation is simple thanks to a graduated scale and following the manual instruction.

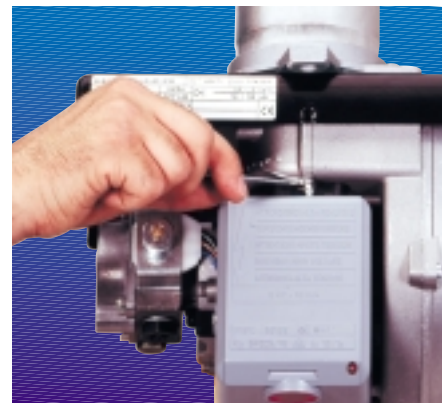

### MAINTENANCE

- ▶ The maintenance position is easily carried out by hinge that joins the body of burner to the flange.





## BURNER ACCESSORIES

Extended head kit

Kits of extended heads are available.

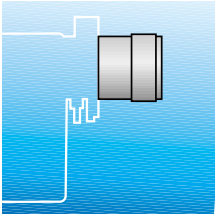

Kit for extended combustion head			
Burner	Standard head length (mm)	Long head version length (mm)	Kit code
F5	76	90	3006001
F5	76	90 INOX	3000688
F5	76	107	3000638
F5	76	121	3000686
F5	76	121 INOX	3000687
F5	STANDARD	CONIC HEAD	3000726
F5	CONIC	107 CILINDRIC HEAD	3000728
F10	108	168	3000643
F10	108	250	3000770
F20	118	178	3000644
F20	118	260	3000771

Spacer kit

Using the special accessories, the burner can be pulled back to reduce head penetration into the combustion chamber.

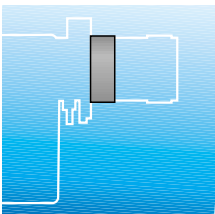

Head length reduction kit			
Burner	Accessory	Pulling back (mm)	Kit code
F5	Spacer	25	3007642
F10	Spacer	25	3000672
F20	Spacer	25	3000673

Light oil filter

Light oil filter	
Burner	Kit code
F5 - F10 - F20	3000926

Biodiesel kit

Kit to use biodiesel	
Burner	Kit code
F5 - F10 - F20	3000978



Remote control release kit for the 530 SE control box

The 530 SE control box can be remotely released using an electric command kit. This kit must be installed in conformity with current regulations in force.

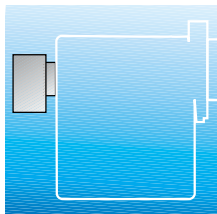

Remote control release kit for the 530 SE control box	
<b>Burner</b>	<b>Kit code</b>
F5 - F10 - F20	3001030

▶ **BALANCED FLUE VERSION**

The R40 series balanced flue oil burner has been specifically designed to meet the increasing trend towards the use of balanced flue, otherwise known as room sealed appliances, which avoid the necessity of having a chimney to discharge the products of combustion.

Balanced flue products are completely sealed from the environment in which they are installed, drawing air for combustion directly from the outside, thereby ensuring no unwelcome smells from combustion of the oil.

As a result of the burner components such as motor, oil pump etc. being completely enclosed this provides an additional benefit of low sound levels.

The R40 balanced flue range has been designed and manufactured to meet the latest European and OFTEC test requirement and are manufactured under quality assurance standards.



*Riello 40 F5 BF*

Overall dimensions (mm)

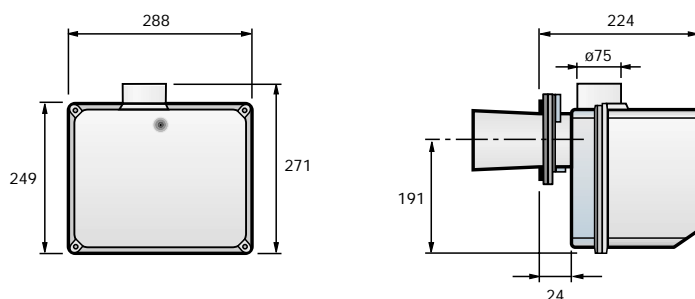



## SPECIFICATION

A special index will help you choose the right burner from the Riello 40 F models available. There is also a clear and detailed product specification and description.

### DESIGNATION OF SERIES

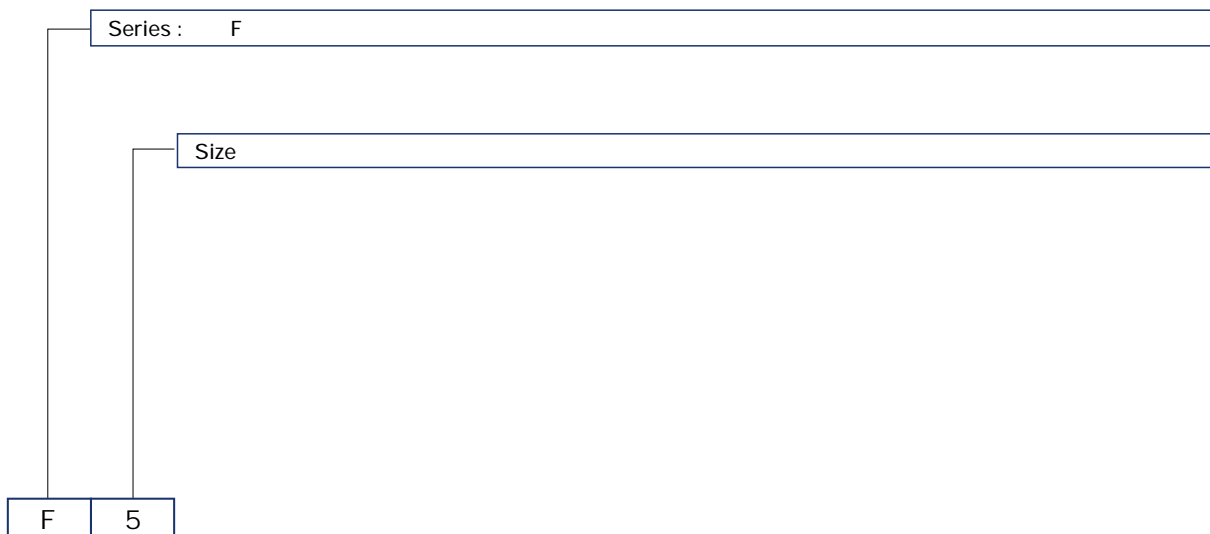

### AVAILABLE BURNER MODELS

<b>F5</b>	30 ÷ 60 kW
<b>F10</b>	54 ÷ 107 kW
<b>F20</b>	95 ÷ 202 kW



## ► SPECIFICATION DESCRIPTION

### *Burner:*

Completely automatic monobloc light oil burners, with one stage operation fitted with:

- Fan with forward inclined blades
- Metallic cover
- Fixed air damper with adjustment
- Single phase electric motor 230 V, 50 Hz
- Combustion head fitted with:
  - stainless steel head cone, resistant to high temperatures
  - ignition electrodes
  - flame stability disk
- Geared pump for fuel supply, fitted with:
  - filter
  - pressure regulator
  - attachments for fitting a pressure gauge and vacuum meter
  - internal by-pass for preparing for single-pipe installations
- Fuel feed solenoid valve incorporated in the pump
- Photocell for flame detection
- Electronic flame control equipment
- Light oil nozzle
- IP 40 protection level.

### Approval:

- EN 267 standard.

### Conforming to:

- Directive 89/336/EEC (electromagnetic compatibility)
- Directive 73/23/EEC (low voltage)
- Directive 98/37/EEC (machinery)
- Directive 92/42/EEC (efficiency).

### Standard equipment:

- Two flexible pipes for connection to the light oil supply line
- Two nipples for connection to the pump
- Flange, screws and nuts for fixing
- Thermal screen
- Instruction handbook for installation, use and maintenance
- Spare parts catalogue.

### Available accessories to be ordered separately:

- Extended head kit
- Spacer kit
- Light oil filter
- Biodiesel kit
- Remote resetting kit
- Balanced flue version.





RIELLO S.p.A. - Via degli Alpini, 1 - 37045 LEGNAGO (VR) Italy  
Tel. ++39.0442630111 - Fax ++39.044221980

Internet: <http://www.rielloburners.com> - E-mail: [rburners@rielloburners.com](mailto:rburners@rielloburners.com)

Since the Company is constantly engaged in the production improvement, the aesthetic and dimensional features, the technical data, the equipment and the accessories can be changed.  
This document contains confidential and proprietary information of RIELLO S.p.A.  
Unless authorised, this information shall not be divulged, nor duplicated in whole or in part.

