

TURBO

Inline mixed-flow fans

Use

- Supply and extract ventilation systems installed in various premises.
- Mounting in kitchens, bathrooms and other humid premises.
- Ventilation air ducts requiring high pressure, powerful air flow and low noise level.
- Compatible with \varnothing 100 up to 315 mm round air ducts.



Air flow:
up to 1750 m³/h
486 l/s



Power:
from 23 W



Noise level:
from 27 dBA



Design

- Casing made of low-flammable polypropylene.
- Ventilation unit with terminal box. Can be turned to any position.
- Special design of the casing permits easy dismantling of the impeller and motor block for fan servicing without dismantling the air duct.

Motor

- Double-speed single-phase motor on ball bearings.
- Equipped with thermal overload protection.

Speed control

- The built-in switch (option **US**) or external switch for multi-speed fans (available upon separate order) are used to select one of two capacity modes.
- Smooth speed control is possible with a built-in speed controller (option **FR**) or an external thyristor speed controller (available upon separate order).

Mounting

- Due to compact design the fan is the ideal solution for mounting in limited spaces, including space behind a false ceiling.
- The fan can be installed in any section of the ventilation system from intake to the end of the ductworks.
- Wall or ceiling mounting with a mounting plate.
- TD:** mounting kit for installation of one diameter fans in parallel (for boosting capacity)



- TL:** mounting kit for installation of one diameter fans in series (for boosting pressure).



Accessories

Silencer	Panel filter	Pocket filter	Electric heater	Water heater	Backdraft air damper	Shutter	Clamp	Temperature controller	Speed controller	Timer / Sensor
SD	KFBK	KFBT	EKH	WKH	VRV	VKA	K	MLCD E2	CDP	CDPI/CDPE

Modifications and options

- o **T**: run-out timer adjustable from 2 to 30 minutes.
- o **US**: three-position speed switch integrated in the fan.



- o **FR**: built-in smooth speed controller adjustable from 0 to 100 %. The fan is supplied with a pre-wired cable with IEC plug as a standard. The cable modification with a standard electric plug is also available (**FR1**).



- o **G**: smooth speed controller with an electronic thermostat and an external temperature sensor that is fixed on 4 m cable. The fan is supplied with a pre-wired power cable with IEC plug as a standard. The cable modification with a standard electric plug is also available (**G1**).



- o **GI**: smooth speed controller with an electronic thermostat and a temperature sensor integrated into the air duct. The fan is supplied with a pre-wired power cable with IEC plug as a standard. The cable modification with a standard electric plug is also available (**GI1**). The options **G** and **GI** are used for automatic speed control depending on indoor temperature. The best ventilation solution for premises requiring permanent temperature control as greenhouses, orangeries, etc.
- o **W**: the fan is equipped with a pre-wired power cable and IEC plug as a standard. Modification with a standard electric plug is available (**W1**).

Designation key		
Series	Duct diameter [mm]	Options
Turbo	100; 125; 150; 160; 200; 250; 315	<p>T: run-out timer adjustable from 2 to 30 minutes.</p> <p>US: three-position speed switch integrated in the fan.</p> <p>FR: built-in smooth speed controller adjustable from 0 to 100 %. The fan is supplied with a pre-wired cable with IEC plug as a standard.</p> <p>FR1: built-in smooth speed controller adjustable from 0 to 100 %. The fan is supplied with a pre-wired cable with a standard electric plug.</p> <p>G: smooth speed controller with an electronic thermostat and an external temperature sensor that is fixed on 4 m cable. The fan is supplied with a pre-wired cable with IEC plug as a standard.</p> <p>GI: smooth speed controller with an electronic thermostat and an external temperature sensor that is fixed on 4 m cable. The fan is supplied with a pre-wired power cable with a standard plug.</p> <p>GI1: smooth speed controller with an electronic thermostat and a temperature sensor integrated into the air duct. The fan is supplied with a pre-wired power cable with IEC plug as a standard.</p> <p>GI1: smooth speed controller with an electronic thermostat and a temperature sensor integrated into the air duct. The fan is supplied with a pre-wired power cable with a standard electric plug.</p> <p>W: the fan is equipped with a pre-wired power cable and IEC plug as a standard.</p> <p>W1: the fan is equipped with a pre-wired power cable and a standard electric plug.</p>

Overall dimensions [mm]

Model	ØD	ØD1	B	H	L	Weight [kg]
Turbo 100	97	164	196	241	303	1.68
Turbo 125	123	164	196	241	258	1.79
Turbo 150	148	187	220	251	289	3.18
Turbo 160	158	187	220	251	289	3.23
Turbo 200	199	209	239	261	295.5	3.8
Turbo 250	247	257	287	323	383	7.83
Turbo 315	310	323	362	408	445	11.7

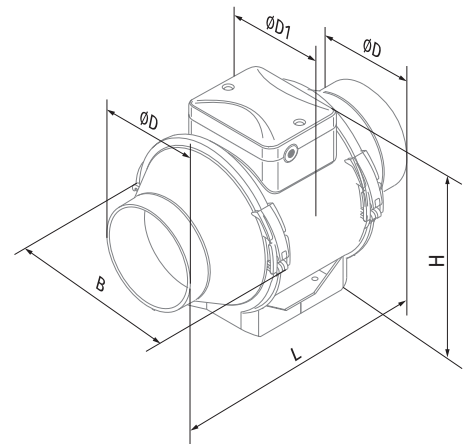

Technical data

Parameters	Turbo 100		Turbo 125		Turbo 150 / Turbo 160	
Speed	min	max	min	max	min	max
Voltage [V / 50-60 Hz]	1 ~ 230	1 ~ 230	1 ~ 230	1 ~ 230	1 ~ 230	1 ~ 230
Power [W]	23	25	25	29	42	50
Current [A]	0.10	0.11	0.11	0.13	0.19	0.22
Maximum air flow [m ³ /h (l/s)]	170 (47)	220 (61)	230 (64)	345 (96)	430 (119)	560 (156)
RPM [min ⁻¹]	1980	2545	1535	2265	1940	2620
Sound pressure level at 3 m [dBA]	27	32	29	34	32	44
Max. transported air temperature [°C]	60		60		60	
SEC class	C		B		B	
Ingress protection rating	IPX4		IPX4		IPX4	
Motor IP rating	IPX4		IPX4		IPX4	
ErP	-		-		2016, 2018	

TURBO 100

Sound power level, A-weighted	Octave frequency band, Hz									LpA, 3 m dBA	LpA, 1 m dBA
	Gen.	63	125	250	500	1000	2000	4000	8000		
Min speed											
L _{WA} to inlet [dBA]	54	16	28	51	45	49	41	35	24	33	43
L _{WA} to outlet [dBA]	53	15	27	50	44	48	40	35	23	32	42
L _{WA} to env. [dBA]	48	11	23	44	40	43	36	31	21	27	37
Max speed											
L _{WA} to inlet [dBA]	64	23	35	61	58	56	48	43	30	43	53
L _{WA} to outlet [dBA]	63	22	34	60	57	55	48	42	29	42	52
L _{WA} to env. [dBA]	56	17	29	53	51	50	43	38	26	38	46

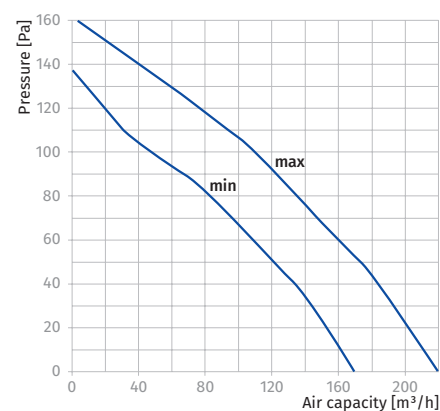
TURBO 125

Sound power level, A-weighted	Octave frequency band, Hz									LpA, 3 m dBA	LpA, 1 m dBA
	Gen.	63	125	250	500	1000	2000	4000	8000		
Min speed											
L _{WA} to inlet [dBA]	54	26	38	52	50	44	38	27	17	34	44
L _{WA} to outlet [dBA]	54	25	37	51	49	43	38	28	18	33	43
L _{WA} to env. [dBA]	49	21	32	46	45	40	35	25	16	29	39
Max speed											
L _{WA} to inlet [dBA]	60	20	31	57	51	51	50	39	27	39	49
L _{WA} to outlet [dBA]	59	20	31	56	51	51	49	39	26	38	48
L _{WA} to env. [dBA]	54	16	27	51	46	47	45	36	24	34	44

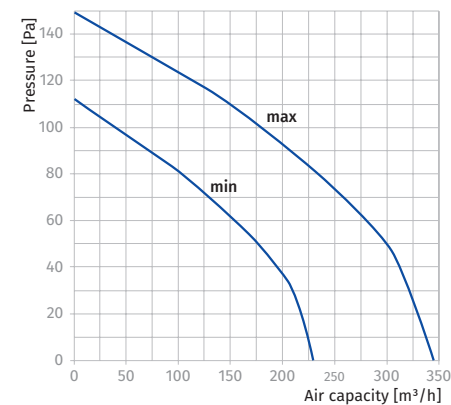
TURBO 150 / 160

Sound power level, A-weighted	Octave frequency band, Hz									LpA, 3 m dBA	LpA, 1 m dBA
	Gen.	63	125	250	500	1000	2000	4000	8000		
Min speed											
L _{WA} to inlet [dBA]	59	31	45	54	52	54	48	35	29	38	48
L _{WA} to outlet [dBA]	63	37	49	56	56	60	48	39	30	42	52
L _{WA} to env. [dBA]	52	21	30	48	48	45	42	34	23	32	42
Max speed											
L _{WA} to inlet [dBA]	69	38	51	57	62	60	66	49	44	48	58
L _{WA} to outlet [dBA]	72	42	55	66	67	68	65	53	45	52	62
L _{WA} to env. [dBA]	65	23	37	56	59	57	61	47	35	44	54

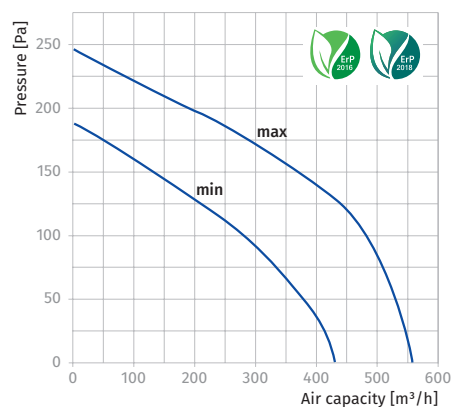

Parameters	Turbo 200		Turbo 250		Turbo 315	
Speed	min	max	min	max	min	max
Voltage [V / 50-60 Hz]	1 ~ 230	1 ~ 230	1 ~ 230	1 ~ 230	1 ~ 230	1 ~ 230
Power [W]	76	108	125	177	227	315
Current [A]	0.34	0.48	0.54	0.79	0.99	1.42
Maximum air flow [m³/h (l/s)]	805 (224)	1080 (300)	1070 (297)	1360 (378)	1420 (394)	1750 (486)
RPM [min⁻¹]	1915	2380	1955	2440	2115	2505
Sound pressure level at 3 m [dBA]	39	45	44	51	41	52
Max. transported air temperature [°C]	60		60		60	
SEC class	B		-		-	
Ingress protection rating	IPX4		IPX4		IPX4	
Motor IP rating	IPX4		IPX4		IPX4	
ErP	2016, 2018		2016, 2018		2016, 2018	

TURBO 200

Sound power level, A-weighted	Octave frequency band, Hz									LpA, 3 m dBA	LpA, 1 m dBA
	Gen.	63	125	250	500	1000	2000	4000	8000		
Min speed											
LWA to inlet [dBA]	66	38	50	58	59	60	59	55	45	45	55
LWA to outlet [dBA]	64	40	50	54	58	59	57	51	44	43	53
LWA to env. [dBA]	60	27	42	49	54	55	54	46	34	39	49
Max speed											
LWA to inlet [dBA]	71	41	50	63	64	65	64	62	52	50	60
LWA to outlet [dBA]	70	43	52	61	66	64	63	58	51	50	60
LWA to env. [dBA]	65	34	43	54	60	60	60	53	41	45	55

TURBO 250

Sound power level, A-weighted	Octave frequency band, Hz									LpA, 3 m dBA	LpA, 1 m dBA
	Gen.	63	125	250	500	1000	2000	4000	8000		
Min speed											
LWA to inlet [dBA]	72	48	57	63	66	69	64	54	45	52	62
LWA to outlet [dBA]	75	48	56	64	70	71	66	56	45	54	64
LWA to env. [dBA]	65	32	51	57	61	59	56	45	32	44	54
Max speed											
LWA to inlet [dBA]	78	52	62	66	71	75	72	62	52	58	68
LWA to outlet [dBA]	81	52	60	66	76	77	74	63	52	60	70
LWA to env. [dBA]	72	35	50	63	69	66	63	53	40	51	61

TURBO 315

Sound power level, A-weighted	Octave frequency band, Hz									LpA, 3 m dBA	LpA, 1 m dBA
	Gen.	63	125	250	500	1000	2000	4000	8000		
Min speed											
LWA to inlet [dBA]	72	43	54	62	67	66	67	58	47	52	62
LWA to outlet [dBA]	70	45	57	59	64	66	63	56	46	50	60
LWA to env. [dBA]	62	28	51	53	57	57	54	46	36	41	51
Max speed											
LWA to inlet [dBA]	80	50	59	68	73	77	74	70	59	60	70
LWA to outlet [dBA]	78	51	60	66	70	75	71	66	57	58	68
LWA to env. [dBA]	72	37	51	66	66	67	65	58	48	52	62

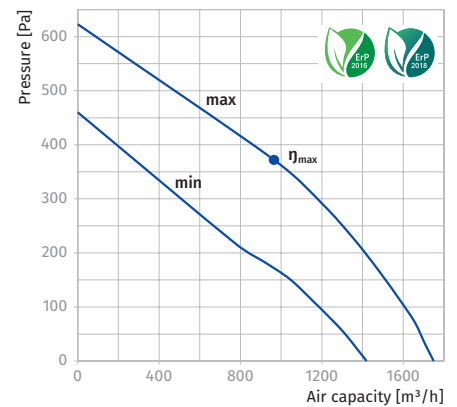
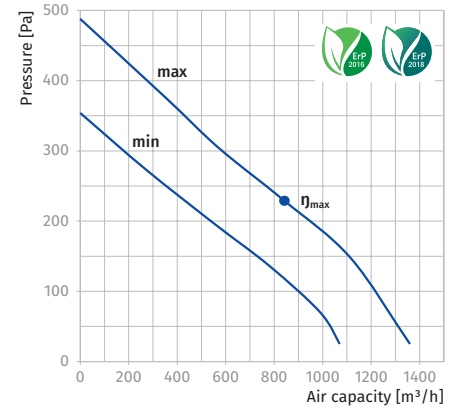
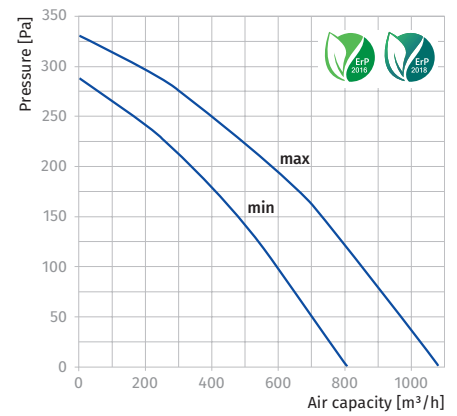

INLINE FANS