



Exhaust centrifugal fans

Box-D

Air capacity – up to 531 m³/h



Use

- Exhaust ventilation systems installed in various premises.
- Mounting into suspended ceiling.
- Compatible with Ø 100, 125 and 150 mm round air ducts.

Design

- Compact galvanized steel casing.
- The front panel is made of ABS plastic and is equipped with a replaceable filter.
- The filter protects motor, impeller and air ducts against soiling.
- Fitted with a spring-loaded damper for back drafting prevention.
- Connecting spigot is equipped with rubber seal.
- External terminal block for power supply.

Motor

- Single-phase external rotor motor. Centrifugal impeller with backward curved blades.
- Equipped with ball bearings for longer service life.
- Integrated thermal protection with automatic restart.
- Dynamically balanced turbine.

Speed control

- Smooth speed control with an external thyristor controller or step speed control with an external auto transformer (both available upon separate order).

Mounting

- The fan is installed between ceiling and false ceiling by fixing brackets supplied as a standard.
- Power is supplied to the fan through an external terminal box.
- Flexible air duct is fixed on fan spigot with a clamp.

Modifications and options

- L – low-powered motor.

Overall dimensions

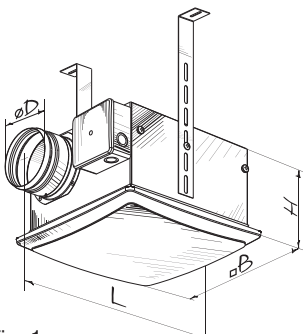

Fig. 1

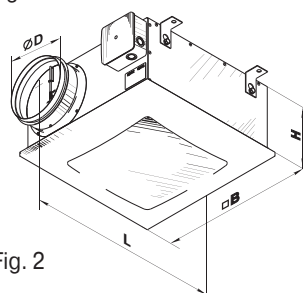







Fig. 2

Type	Dimensions [mm]				Weight [kg]	Fig.no.
	$\varnothing D$	B	H	L		
Box-D 100 L	100	240	160	305	2.9	1
Box-D 100	100	240	160	305	3.2	1
Box-D 125 L	125	240	160	305	2.9	1
Box-D 125	125	240	160	305	3.2	1
Box-D 150	149	355	180	419	6.5	2

Specifications

Parameters	Box-D 100 L 		Box-D 100 		Box-D 125 L 		Box-D 125 		Box-D 150 	
	Voltage [V]	1 ~ 230		1 ~ 230		1 ~ 230		1 ~ 230		1 ~ 230
Frequency [Hz]	50	60	50	60	50	60	50	60	50	60
Power [W]	56	58	61	79	56	58	61	81	112	136
Current [A]	0.34	0.35	0.26	0.35	0.34	0.35	0.26	0.36	0.5	0.6
Max. air capacity [m ³ /h]	190	205	240	250	225	240	310	320	485	531
RPM [min ⁻¹]	2300	2570	2500	2730	2300	2570	2500	2740	2465	2550
Noise level at 3 m [dBA]	42	43	47	48	43	44	48	49	52	53
Transported air temperature [°C]	-25..+45		-25..+50		-25..+45		-25..+50		-25..+50	
SEC class	C									-
Protection rating	IPX4		IPX4		IPX4		IPX4		IPX4	

