

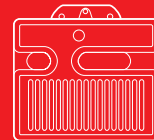

## RIELLO 40 G Series

One Stage Light Oil Burners

G3	23.8 ÷	35.5	kW
G3R	23.8 ÷	35.5	kW
G3RK	15.0 ÷	35.0	kW
G5	28.0 ÷	60.0	kW
G5R	28.0 ÷	60.0	kW
G5RK	12.0 ÷	60.0	kW
G7	29.0 ÷	69.0	kW
G10	54.0 ÷	120.0	kW
G20	95.0 ÷	213.0	kW
G20S	95.0 ÷	240.0	kW



The Riello 40 G series of one stage light oil burners, is a complete range of products developed to respond to any request for home heating. The Riello 40 G series is available in ten different models, with an output ranging from 12 to 240 kW, divided into four different structures.

All the models use the same components designed by Riello for the Riello 40 G series. The high quality level guarantees safe working.

In developing these burners, special attention was paid to reducing noise, to the ease of installation and adjustment, obtaining the smallest size possible to fit into any sort of boiler available on the market.

All the models are approved by the EN 267 European Standard and conform to European Directives for EMC, Low Voltage, Machinery and Boiler Efficiency.

All the Riello 40 G burners are fired before leaving the factory.

## Technical Data

MODEL		R40 G3	R40 G3R	R40 G3RK	
Burner operation mode		One stage			
Modulation ratio at max. output		===			
Servomotor	type	===			
	run time s	===			
Heat output	kW	23.8 ÷ 35.5	23.8 ÷ 35.5	15 ÷ 35	
	Mcal/h	20.4 ÷ 30.5	20.4 ÷ 30.5	12.9 ÷ 30.1	
	Kg/h	2 - 3	2 - 3	1.3 - 3	
Working temperature	°C min./max.	0/40			
<b>FUEL/AIR DATA</b>					
Light oil	net calorific value	kWh/kg	11.8		
		kcal/kg	10200		
	viscosity at 20°C	mm <sup>2</sup> /s (cSt)	4 - 6 (at 20°C)		
Pump	type	R.B.L			
	delivery	Kg/h	30 (at 12 bar)		
Atomised pressure	bar	8 - 15			
Fuel temperature	max. °C	50			
Fuel pre-heater		NO	YES	YES	
Fan	type	Centrifugal with forward curve blades			
Air temperature	max. °C	40			
<b>ELECTRICAL DATA</b>					
Electrical supply	Ph/Hz/V	1/50/230 ± 10%			
Auxiliary electrical supply	Ph/Hz/V	===			
Control box	type	RBL 530 SE	RBL 531 SE	RBL 531 SE	
Total electrical power	kW	0.115	0.165	0.170	
Auxiliary electrical power	kW	===			
Heaters electrical power	kW	===	0.055		
Protection level	IP	X0D (IP 40)			
Fan motor	electrical power	kW	0.09		
	rated current	A	0.7		
	start up current	A	2.8		
	protection level	IP	20		
Pump motor	electrical power	kW	===		
	rated current	A	===		
	start up current	A	===		
	protection level	IP	===		
Ignition transformer	type	Incorporated in the control box			
	V1 - V2	(==) - 8 Kv			
	I1 - I2	(==) - 30 mA			
Operation		Intermittent (at least one stop every 24h)			
<b>EMISSIONS</b>					
Noise levels	Sound pressure	dB (A)	57	57	56
	Sound power	dB (A)	68	68	67
	CO emission	mg/kWh	16	11	40
Light oil	grade of smoke indicator	N° Bacharach	< 1		
	CxHy emission	mg/kWh	< 10 (after the first 20s)		
	NOx emission	mg/kWh	170	160	160
<b>APPROVAL</b>					
Directive		2006/42/EC - 92/42/EC - 2014/30/UE - 2014/35/UE			
Conforming to		EN 267			
Certification		===	===	CE-00360254/99	

### Reference conditions:

Temperature: 20°C - Pressure: 1013,5 mbar - Altitude: 0 m a.s.l. - Noise measured at a distance of 1 meter. Sound pressure measured in manufacturer's combustion laboratory, with burner operating on test boiler and at maximum rated output. The sound power is measured with the "Free Field" method, as per EN 15036, and according to an "Accuracy: Category 3" measuring accuracy, as set out in EN ISO 3746.

MODEL		R40 G5	R40 G5R	R40 G5RK
Burner operation mode		One stage		
Modulation ratio at max. output		===		
Servomotor	type	===		
	run time s	===		
Heat output	kW	28 ÷ 60	28 ÷ 60	12 ÷ 60
	Mcal/h	24.1 ÷ 51.6	24.1 ÷ 51.6	10.3 ÷ 51.6
	Kg/h	2.3 - 5	2.3 - 5	1 - 5
Working temperature		°C min./max. 0/40		
<b>FUEL/AIR DATA</b>				
Light oil	net calorific value	kWh/kg	11.8	
		kcal/kg	10200	
	viscosity at 20°C	mm <sup>2</sup> /s (cSt)	4 - 6 (at 20°C)	2 - 6 (at 20°C)
Pump	type	R.B.L		
	delivery	Kg/h	30 (at 12 bar)	
Atomised pressure		bar	8-15	
Fuel temperature		max. °C	50	
Fuel pre-heater			NO	YES YES
Fan		type	Centrifugal with forward curve blades	
Air temperature		max. °C	40	
<b>ELECTRICAL DATA</b>				
Electrical supply		Ph/Hz/V	1/50/230 ± 10%	
Auxiliary electrical supply		Ph/Hz/V	===	
Control box		type	RBL 530 SE	RBL 531 SE RBL 531 SE
Total electrical power		kW	0.130	0.185 0.185
Auxiliary electrical power		kW	===	
Heaters electrical power		kW	===	0.055 0.055
Protection level		IP	X0D (IP 40)	
Fan motor	electrical power	kW	0.09	
	rated current	A	0.75	
	start up current	A	3	
	protection level	IP	20	
Pump motor	electrical power	kW	===	
	rated current	A	===	
	start up current	A	===	
	protection level	IP	===	
Ignition transformer		type	Incorporated in the control box	
		V1 - V2	(==) - 8 Kv	
		I1 - I2	(==) - 30 mA	
Operation		Intermittent (at least one stop every 24h)		
<b>EMISSIONS</b>				
Noise levels	Sound pressure	dB (A)	59	
	Sound power	dB (A)	70	
Light oil	CO emission	mg/kWh	10	10 20
	grade of smoke indicator	N° Bacharach	< 1	
	CxHy emission	mg/kWh	< 10 (after the first 20s)	
	NOx emission	mg/kWh	180	185 175
<b>APPROVAL</b>				
Directive		2006/42/EC - 92/42/EC - 2014/30/UE - 2014/35/UE		
Conforming to		EN 267		
Certification		===	===	CE-00360254/99

## Reference conditions:

Temperature: 20°C - Pressure: 1013,5 mbar - Altitude: 0 m a.s.l. - Noise measured at a distance of 1 meter. Sound pressure measured in manufacturer's combustion laboratory, with burner operating on test boiler and at maximum rated output. The sound power is measured with the "Free Field" method, as per EN 15036, and according to an "Accuracy: Category 3" measuring accuracy, as set out in EN ISO 3746.

MODEL		R40 G7	R40 G10	R40 G20	R40 G20S	
Burner operation mode		One stage				
Modulation ratio at max. output		===				
Servomotor	type	===				
	run time s	===				
Heat output	kW	29 ÷ 69	54 ÷ 120	95 ÷ 213	95 ÷ 240	
	Mcal/h	24.9 - 59.3	46.4 - 103.2	81.7 - 183.2	81.7 - 206.4	
	Kg/h	2.5 - 5.8	4.5 - 10	8 - 18	8.20	
Working temperature	°C min./max.	0/40				
<b>FUEL/AIR DATA</b>						
Light oil	net calorific value	kWh/kg	11.8			
		kcal/kg	10200			
	viscosity at 20°C	mm <sup>2</sup> /s (cSt)	2 - 6 (at 20°C)	4 - 6 (at 20°C)		
Pump	type		R.B.L			
	delivery	Kg/h	30 (at 12 bar)			
Atomised pressure		bar	8 - 15			
Fuel temperature		max. °C	50			
Fuel pre-heater			NO	NO	NO	NO
Fan		type	Centrifugal with forward curve blades			
Air temperature		max. °C	40			
<b>ELECTRICAL DATA</b>						
Electrical supply		Ph/Hz/V	1/50/230 ± 10%			
Auxiliary electrical supply		Ph/Hz/V	===			
Control box		type	RBL 530 SE			
Total electrical power		kW	0.160	0.170	0.320	0.330
Auxiliary electrical power		kW	===			
Heaters electrical power		kW	===			
Protection level		IP	XOD (IP 40)			
Fan motor	electrical power	kW	0.09		0.15	
	rated current	A	0.85	0.8	1.4	1.5
	start up current	A	3.4	3.2	5.6	6
	protection level	IP	20			
Pump motor	electrical power	kW	===			
	rated current	A	===			
	start up current	A	===			
	protection level	IP	===			
Ignition transformer	type		Incorporated in the control box			
	V1 - V2		(==) - 8 Kv			
	I1 - I2		(==) - 30 mA			
Operation		Intermittent (at least one stop every 24h)				
<b>EMISSIONS</b>						
Noise levels	Sound pressure	dB (A)	64	65	74	72
	Sound power	dB (A)	75	76	85	83
	CO emission	mg/kWh	15	15	20	20
Light oil	grade of smoke indicator	N° Bacharach	< 1			
	CxHy emission	mg/kWh	< 10 (after the first 20s)			
	NOx emission	mg/kWh	180	190	180	190
<b>APPROVAL</b>						
Directive		2006/42/EC - 92/42/EC - 2014/30/UE - 2014/35/UE				
Conforming to		EN 267				
Certification		===	CE-00360257/99	===	===	

**Reference conditions:**

Temperature: 20°C - Pressure: 1013,5 mbar - Altitude: 0 m a.s.l. - Noise measured at a distance of 1 meter. Sound pressure measured in manufacturer's combustion laboratory, with burner operating on test boiler and at maximum rated output. The sound power is measured with the "Free Field" method, as per EN 15036, and according to an "Accuracy: Category 3" measuring accuracy, as set out in EN ISO 3746.

# Firing Rates

## RIELLO 40 G3 - G3R - G3RK

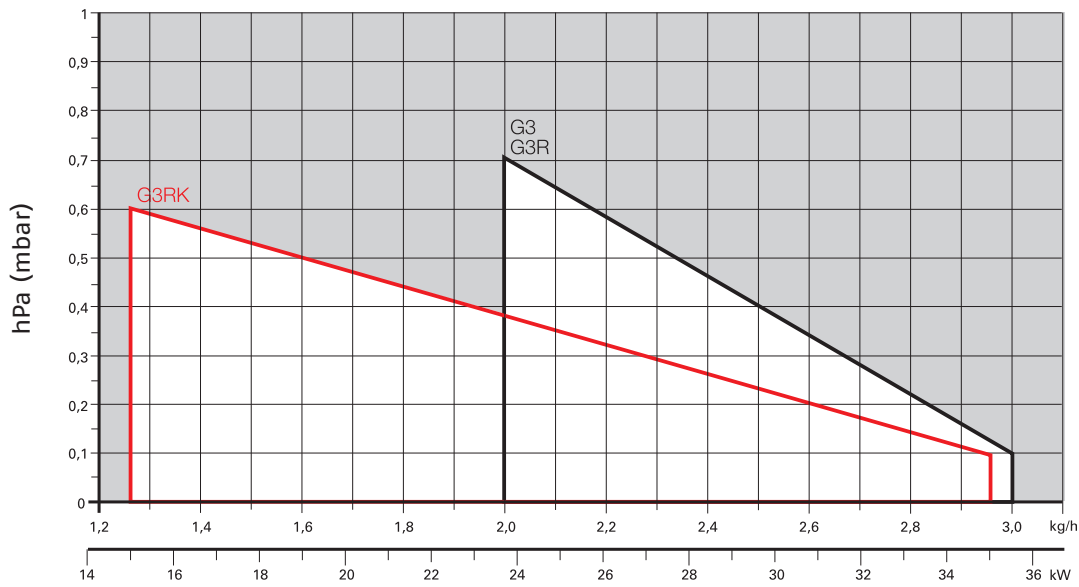

Useful working field for choosing the burner

Test conditions conforming to EN267  
 Temperature: 20°C  
 Pressure: 1013,5 mbar  
 Altitude: 0 m a.s.l.

## RIELLO 40 G5 - G5R - G5RK

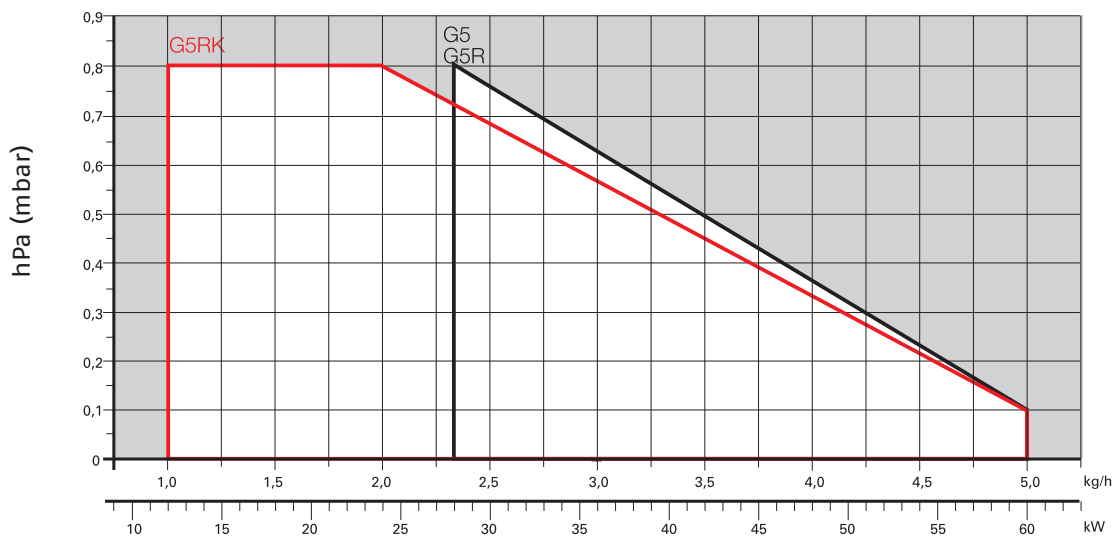

**RIELLO 40 G7 - G10**

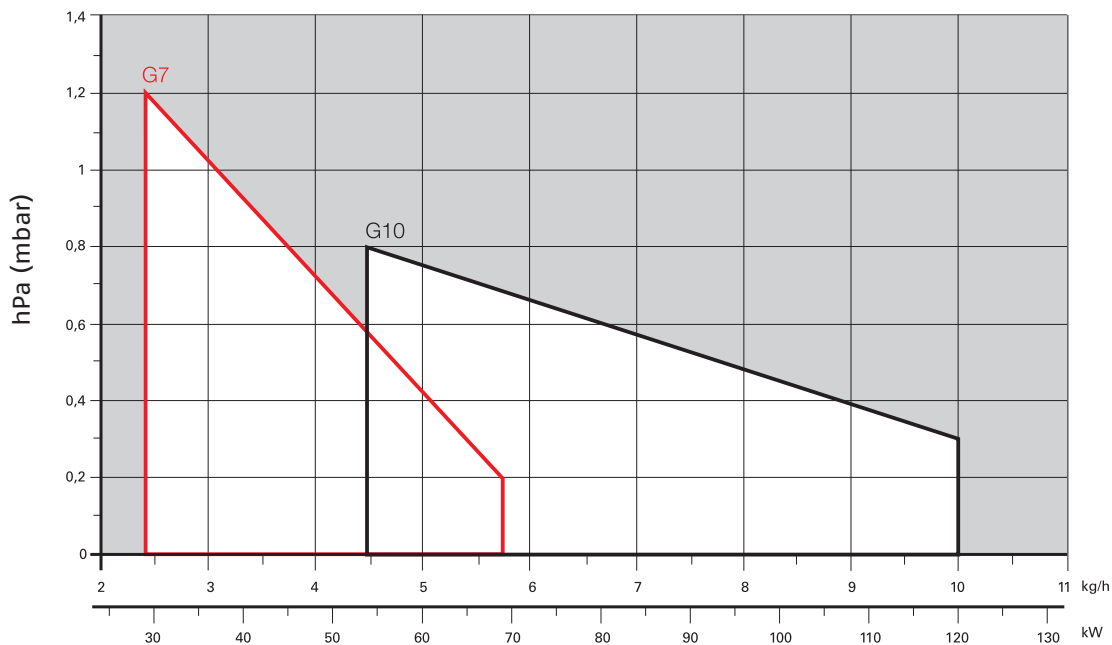

☐ Useful working field for choosing the burner

Test conditions conforming to EN267  
 Temperature: 20°C  
 Pressure: 1013,5 mbar  
 Altitude: 0 m a.s.l.

**RIELLO 40 G20 - G20S**

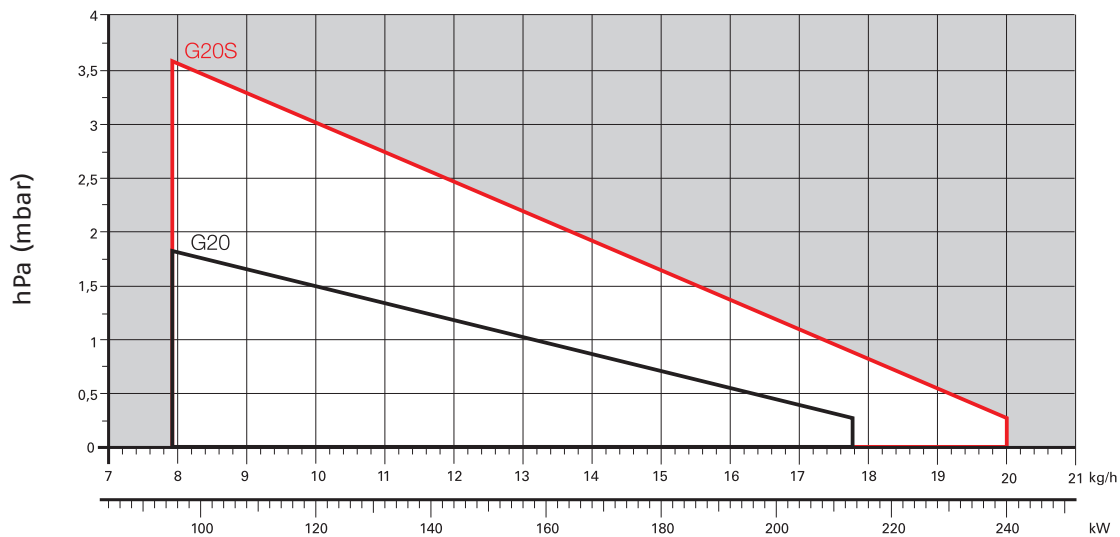

# Fuel Supply

## HYDRAULIC CIRCUIT

All the burners have a R.B.L. geared pump with safety valve on the return circuit.

G3 - G3R - G3K - G5 - G5R - G5RK - G7 - G10 - G20

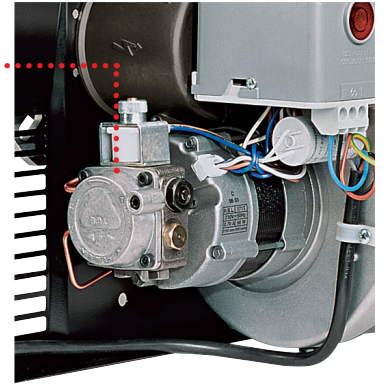
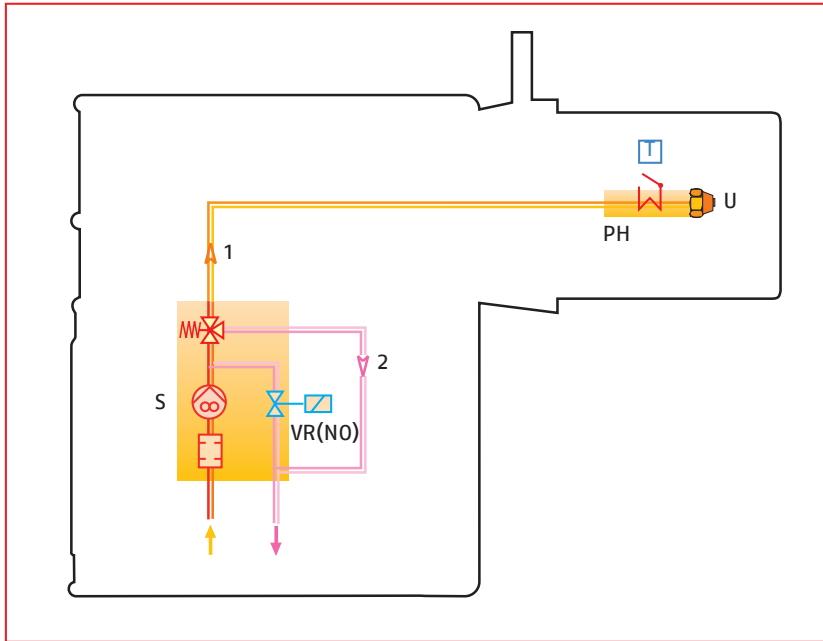

Fuel pump

Fuel feed to the burner can be from the right or the left side on all models.

## G20S

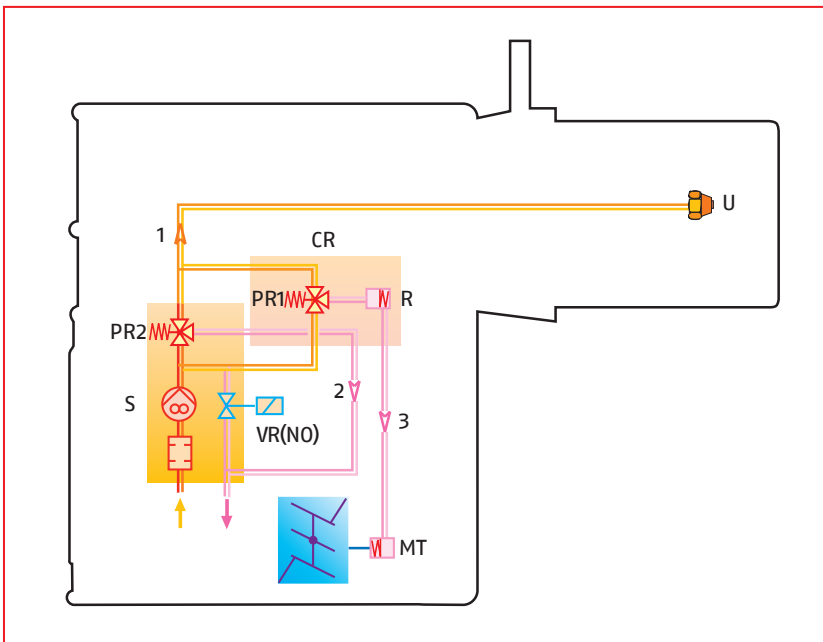

<b>S</b>	Pump with filter and pressure regulator on the delivery pipe
<b>VR (NO)</b>	Oil return valve on the delivery pipe
<b>1</b>	Oil input pipe to the nozzle
<b>2</b>	Oil return pipe from the regulator
<b>3</b>	Oil delivery pipe to the air damper hydraulic jack
<b>MT</b>	Air damper hydraulic jack for high pressure working
<b>PR1</b>	Low pressure oil regulator
<b>PR2</b>	High pressure oil regulator
<b>R</b>	Delayer
<b>CR</b>	Delayer casing
<b>PH</b>	Oil pre-heater with thermostat (where provided)
<b>U</b>	Nozzle



## Light Oil Pre-Heater

The models "R" have light oil pre-heater which is located next of the nozzle, operated by the control box which delays burner ignition before each start in order to adequately pre-heat the oil.

### SELECTING THE FUEL SUPPLY LINES

The fuel feed must be completed with the safety devices required by the local regulations in force.

The table shows the choice of piping diameter for the various burners, depending on the difference in the height between the burner and the tank and the distance between them.

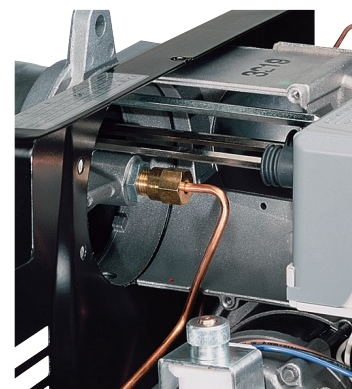

Pre-heater

Maximum equivalent length of the pipework L (m)				
Pipe size	Type A system		Type B system	
	∅ 8 mm	∅ 10 mm	∅ 8 mm	∅ 10 mm
H (m)	$L_{max}$ (m)	$L_{max}$ (m)	$L_{max}$ (m)	$L_{max}$ (m)
0	35	100	-	-
0.5	30	100	10	20
1.0	25	100	20	40
1.5	20	90	40	80
2.0	15	70	60	100
3.0	8	30	-	-
3.5	6	20	-	-

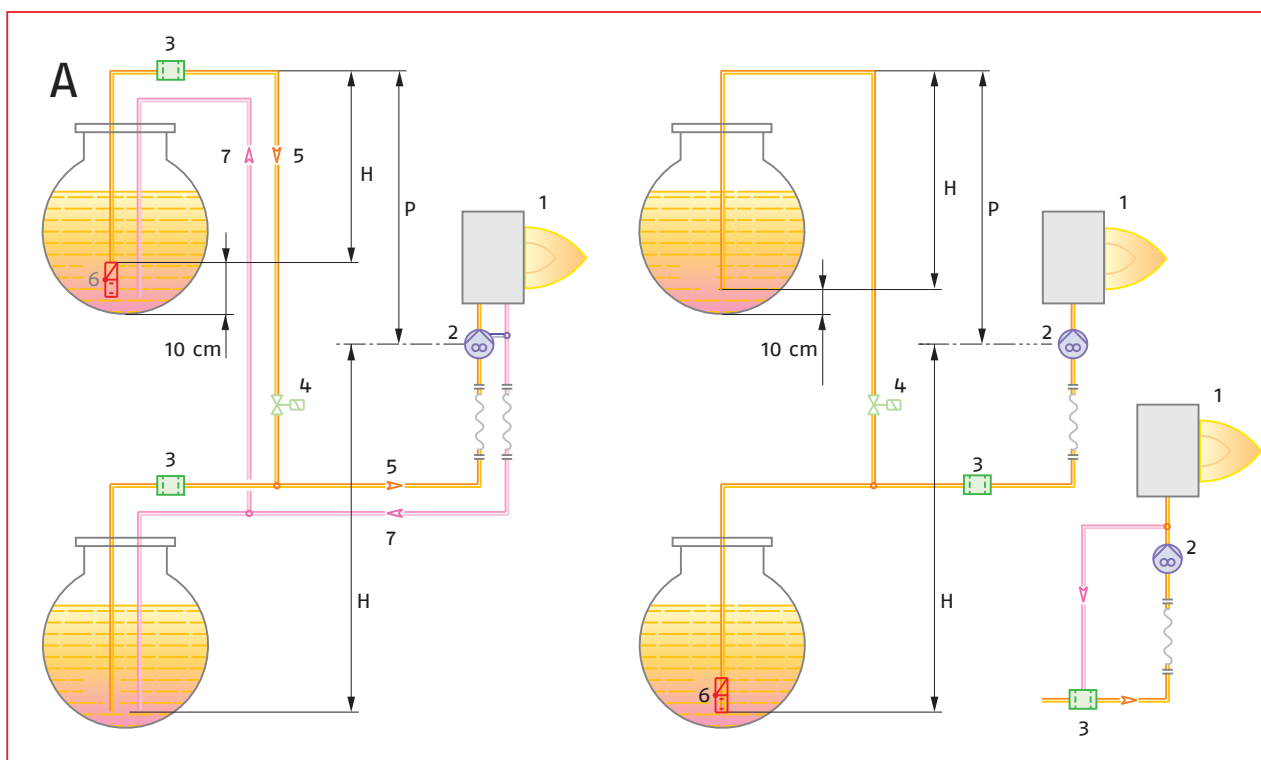

**SELECTING THE FUEL SUPPLY LINES**

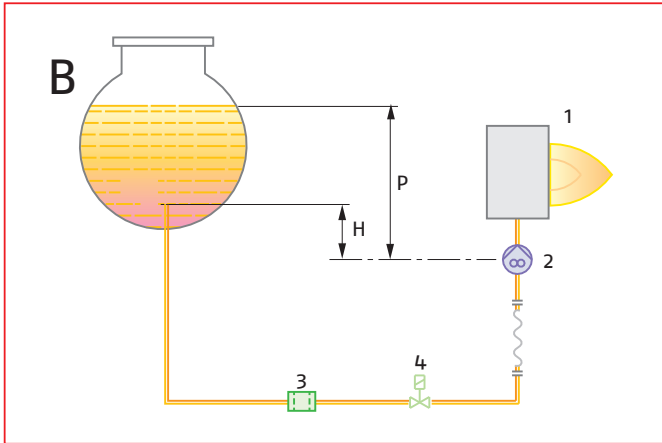

<b>H</b>	Pump/Foot valve height difference
<b>∅</b>	Inside pipe diameter
<b>P</b>	Difference in height ≤ 4 m
<b>1</b>	Burner
<b>2</b>	Pump
<b>3</b>	Filter
<b>4</b>	Shut-off solenoid valve
<b>5</b>	Suction pipework
<b>6</b>	Bottom valve
<b>7</b>	return pipework

**Ventilation**

The ventilation circuits always ensure low noise levels with high performance of pressure and air delivery, inspite of their compact size.



Air suction

**Combustion Head**

The G3 and G3R models all have fixed heads. Certain models allows you to choose the length of the combustion head. This choice depends on the thickness of the front wall and type of the boiler. Depending on the type of generator, you should check the correct penetration of the head into the combustion chamber. Simple adjustment to the combustion head allows adapting internal geometry of the head to the maximum rated output of the burner.

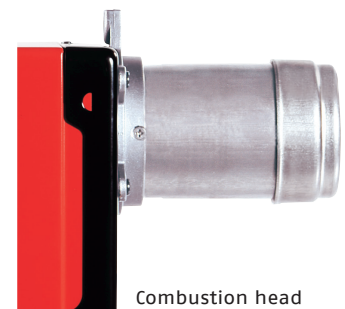

Combustion head

**SUGGESTED COMBUSTION CHAMBER DIMENSIONS**

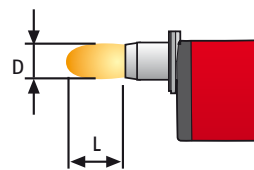
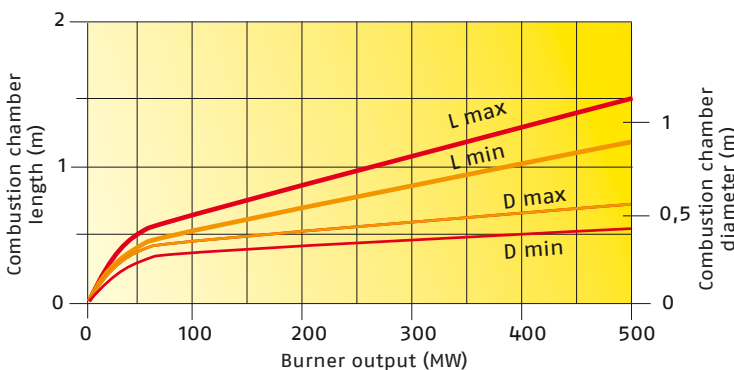

Example:  
 Burner thermal output = 350 kW;  
 L Combustion Chamber (m) = 1.2 m (medium value);  
 D Combustion Chamber (m) = 0,8 m (medium value)

# Operation

## BURNER OPERATION MODE

All these models are one stage operation; the G20S model is one stage operation with reduced output firing.

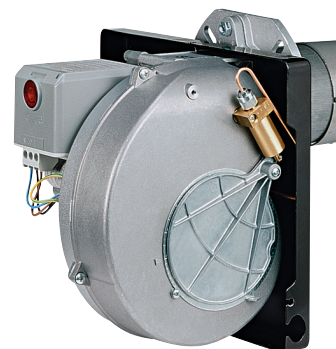

Air damper

One stage operation

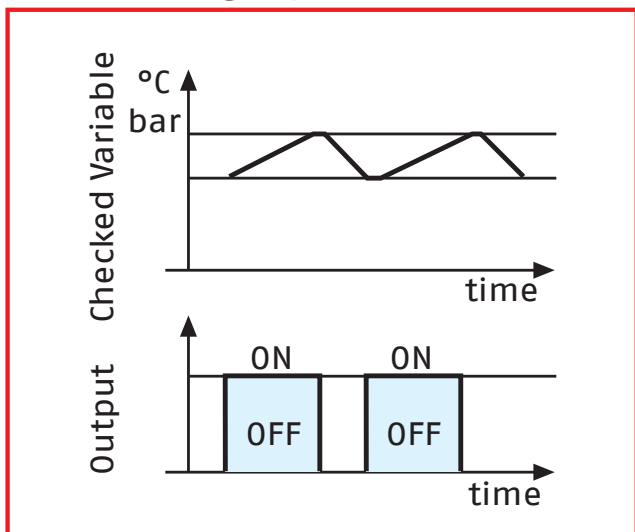

One stage operation with reduced output ignition

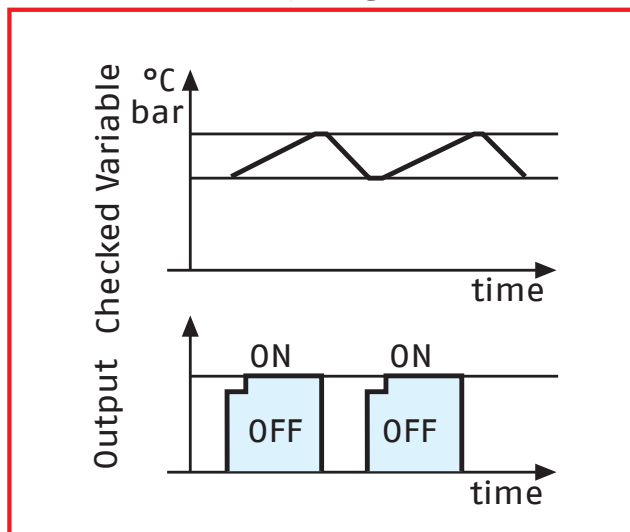

**START UP CYCLE**

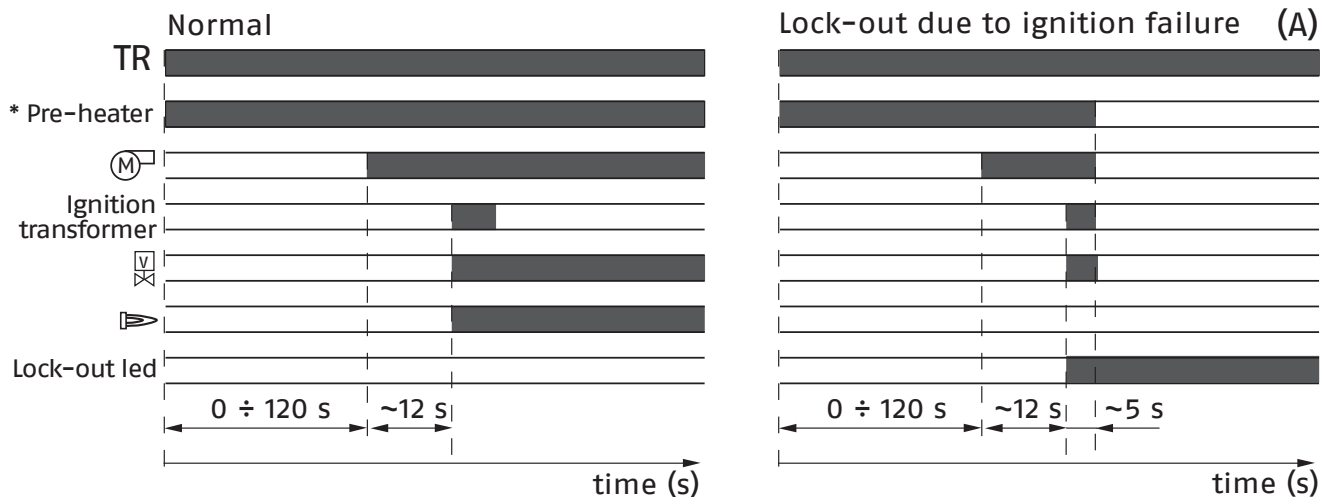

\* Only model with pre-heater.

(A) Lock-out is shown by a led on the appliance.

**CORRECT OPERATION**

- 0s The burner begins the ignition cycle.
- 0s-12s Pre-purge with the air damper open.
- 12s Ignition.

\* If the pre-heater is fitted (G...R series), there is a further delay before pre-purge; this delay can reach 120s depending on room and fuel temperatures.

**LOCK-OUT DUE TO IGNITION FAILURE**

If the flame does not light within the safety limit (~ 5s) the burner locks-out.

**ELECTRICAL CONNECTIONS**

Electrical connections must be made by qualified and skilled personnel in conformity with the local regulations in force.

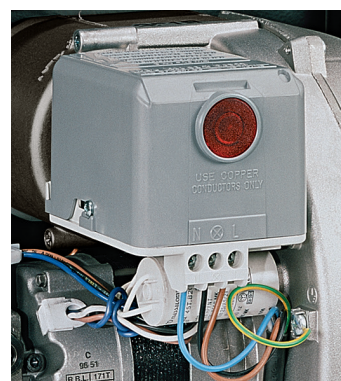

Control box fitted with an ignition transformer

## Emissions

The emission data has been measured in the various models at maximum output, according to EN 267 standard.

### NO2 EMISSIONS

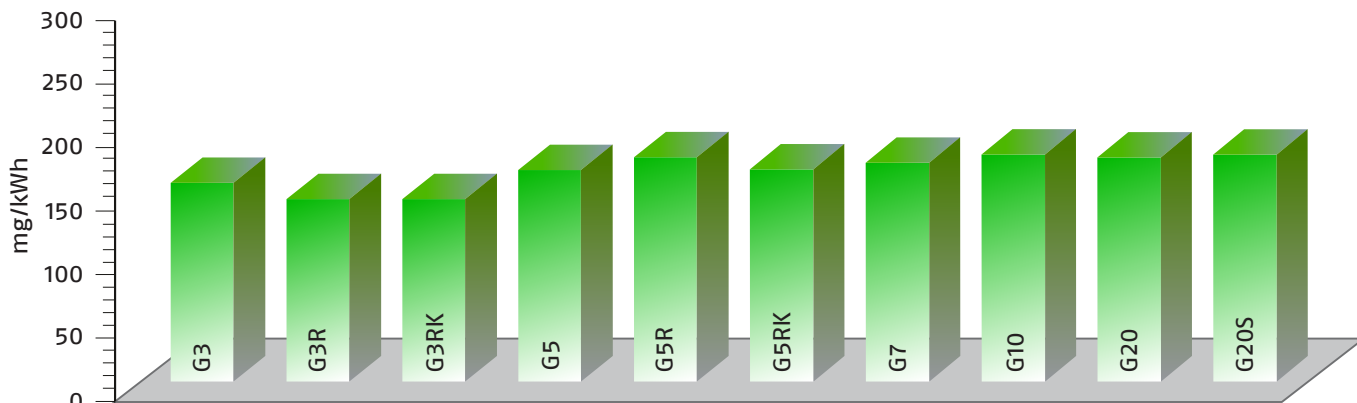

### CO EMISSIONS

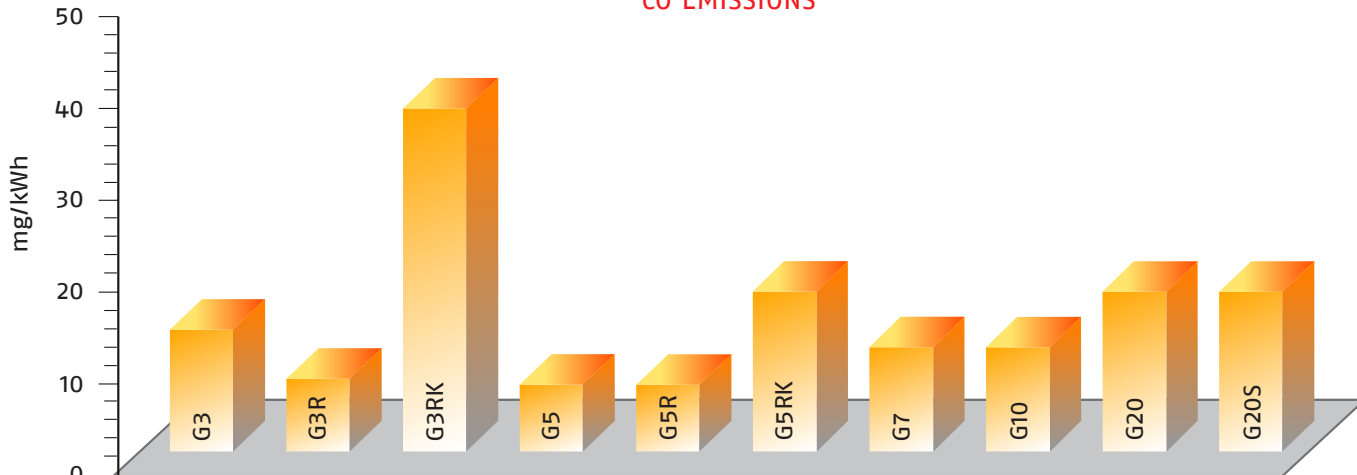

### NOISE EMISSIONS

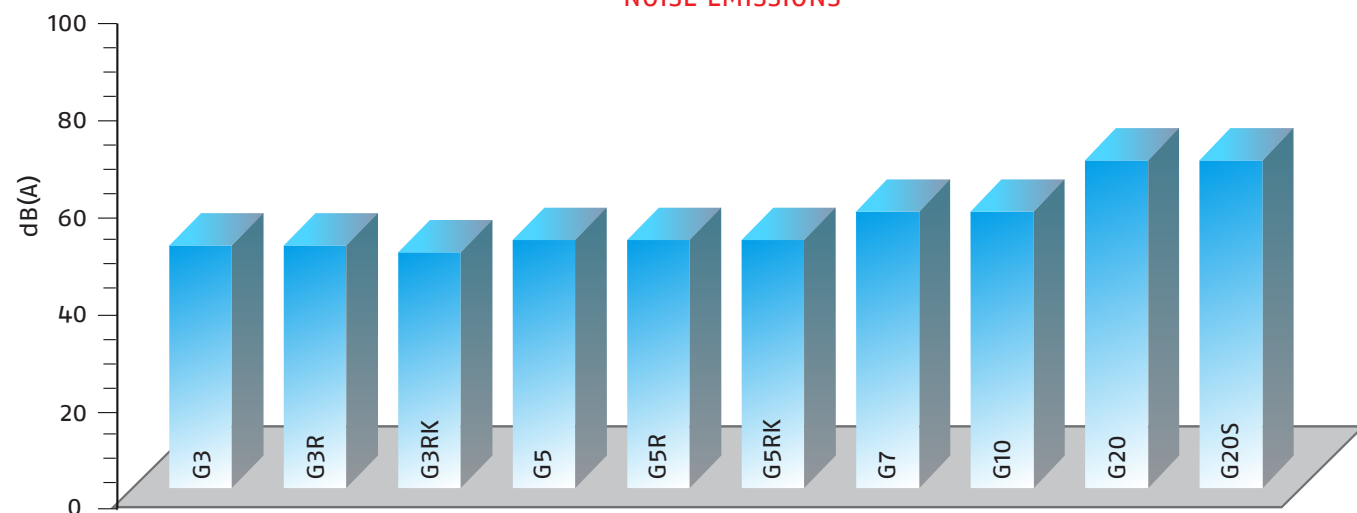

Special attention has been paid to noise reduction. All models are fitted with sound-proofing material inside the cover.

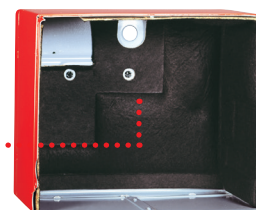

## Overall Dimensions (mm)

These models are distinguished by their reduced size, in relation to their outputs, which means they can be fitted to any boiler on the market.

### BURNER

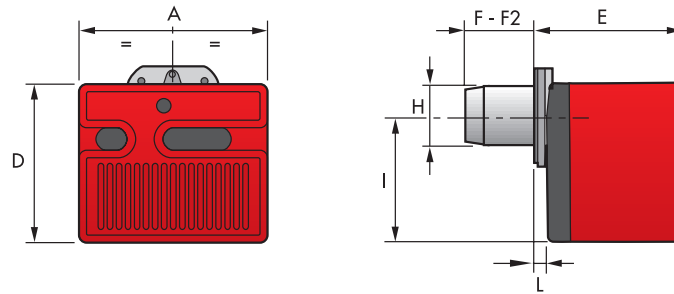

MODEL	A	D	E	F	F2	H	I	L
G3	252	215	203	86	-	89	164	19
G3R	252	215	203	86	-	89	164	19
G3RK	252	215	203	97	115	89	164	19
G5	272	233	236	107 - 180	-	89	180	37
G5R	272	233	236	107	-	89	180	37
G5RK	272	233	236	94	112	89	180	37
G7	305	262	261	73	-	89	204	40
G10	305	262	261	108 - 250	-	105	204	40
G20	350	298	295	118 - 260	-	125	230	41
G20S	350	298	295	118	-	125	230	41

### BURNER - BOILER MOUNTING FLANGE

G3 - G3R - G3RK - G5 - G5R - G5RK - G7 - G10

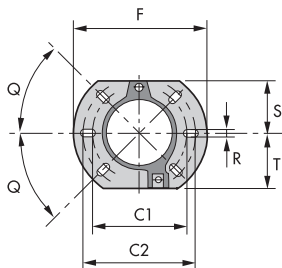

G20 - G20S

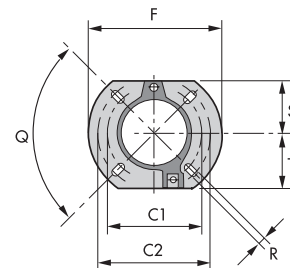

MODEL	C1	C2	F	Q	R	S	T
G3 - G3R - G3RK - G5 - G5R - G5RK	130	150	180	45°	11	72	75
G7 - G10	140	170	189	45°	11	83	83
G20 - G20S	160	190	213	90°	11	99	99

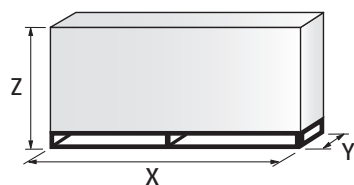
**PACKAGING**

MODEL	X	Y	Z	kg
G3	363	295	310	10
G3R	363	295	310	10
G3RK	363	295	310	10,5
G5	383	315	325	12
G5R	383	315	325	12
G5RK	383	315	325	12
G7	423	348	340	13
G10	423	348	340	13
G20	483	393	377	16
G20S	483	393	377	17,5

## Installation Description

Skilled and qualified personnel must perform installation, start up and maintenance. A nozzle is fitted to the burner and used for fire tests in the factory. If necessary, change the nozzle on the basis of the maximum output of the boiler. All operations must be carried in accordance with the technical handbook supplied with the burner.

### BURNER SETTING

Air damper and head adjustment area are easily accessible and the operation is simple thanks to a graduated scale and following the manual instruction.

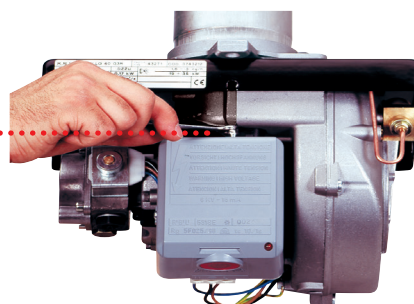
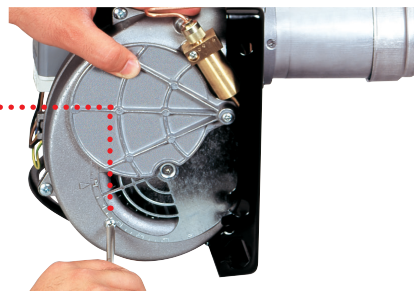

The pressure regulator is carried out by setting the adjustment screw.

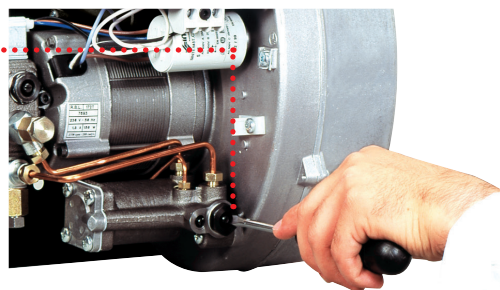

### ELECTRICAL CONNECTIONS AND MAINTENANCE

Electrical wirings are easily thanks to plug and socket connections. The 7 pin plug is supplied for connection to the boiler.

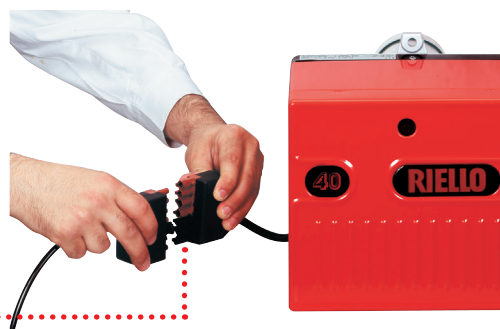



## Burner accessories

### REMOTE CONTROL RELEASE KIT FOR 530-531 CONTROL BOXES

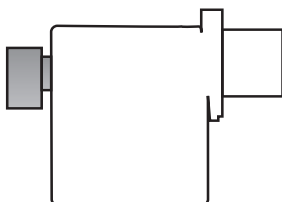

The 530-531 control boxes can be remotely released using an electric command kit. This kit must be installed in conformity with current regulations in force.

BURNER	CODE
All models	3001030

### EXTENDED HEAD KIT

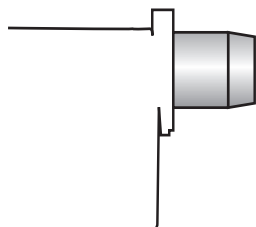

Kits of extended heads are available.

BURNER	STANDARD HEAD LENGTH (mm)	EXTENDED HEAD LENGTH (mm)	CODE
G5 - G5R	107	121	3000686
G5 - G5R	107	121 inox	3000687
G5 - G5R	107	94 - 112 (conic head)	3000726
G10	108	168	3000643
G10	108	250	3000770
G20 - G20S	118	178	3000644
G20 - G20S	118	260	3000771

### SPACER KIT

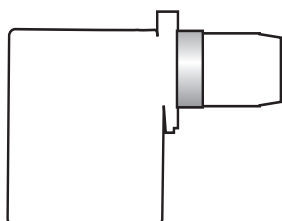

Using the special accessories, the burner can be pulled back to reduce head penetration into the combustion chamber.

BURNER	SPACER THICKNESS S (mm)	CODE
G3 - G3R - G3RK - G5 - G5R - G5RK - G7	25	3000642
G10	25	3000672
G20 - G20S	25	3000673

### INLET AIR ASPIRATION KIT

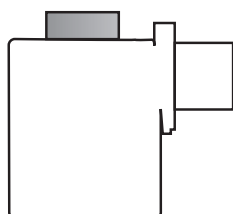

This kit allows to channel the external air directly into the burner and is available as accessory for models:

BURNER	CODE
G3 - G3R - G3RK	20027471
G5 - G5R - G5RK	20027574
G7 - G10	20027577
G20 - G20S	20027580

**LIGHT OIL FILTER**



For cleaning light oil from dirty particles and impurities filters with the following features are available:

BURNER	FILTERING DEGREE (µm)	CODE
All models	60	3006561

Filter made up of aluminium body and stainless steel filtering cartridge; available singularly.

BURNER	FILTERING DEGREE (µm)	CODE
All models	60	3075011

Filter made up of aluminium cover, plastic tank and nylon filtering cartridge; available in packaging of 50 pieces.

**LIGHT OIL FILTER/DEGASSING UNIT**



To solve problems of air or water in the oil circuit a special filter/degassing unit is available, made up of aluminium cover, plastic tank, stainless steel filtering cartridge, air release cap and water purge valve. It is available singularly.

BURNER	FILTERING DEGREE (µm)	CODE
All models	100	3000926

**7-PIN PLUG KIT**

If necessary a 7-pin plug kit is available (in packaging of n. 5 pieces).

BURNER	CODE
All models	300945

**HOUR COUNTER KIT FOR 530 SE AND 531 SE CONTROL BOXES**



To measure the burner working time a hour counter kit is available.

BURNER	CODE
All models	3000904



**7-POLE SOCKET KIT FOR 530 SE AND 531 SE CONTROL BOXES**

For burner without pre installed socket a 7-pole socket kit with cable is available.

BURNER	CODE
All models	3001065

**BALANCED FLUE VERSION**

The Riello 40 series balanced flue oil burner has been specifically designed to meet the increasing trend towards the use of balanced flue, otherwise known as room sealed appliances, which avoids the necessity of having a chimney to discharge the products of combustion.

Balanced flue products are completely sealed from the environment in which they are installed, drawing air for combustion directly from the outside, thereby ensuring no unwelcome smells from combustion of the oil.

As a result of the burner components such as motor, oil pump etc. being completely enclosed this provides an additional benefit of low sound levels.

The Riello 40 balanced flue range has been designed and manufactured to meet the latest European and OFTEC test requirement and are manufactured under quality assurance standards.

Riello 40 balanced flue version is available for the following models: G3, G3R, G3RK, G5, G5R, G5RK.



Riello 40 balanced flue version

**OVERALL DIMENSIONS (mm)**

**G3 - G3R - G3RK**

**G5 - G5R - G5RK**

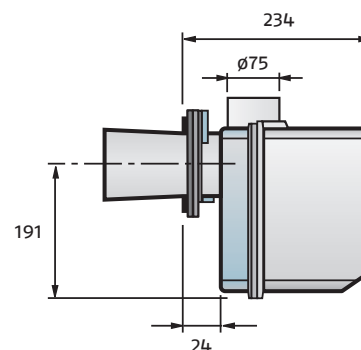
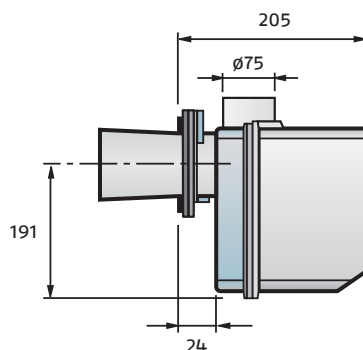
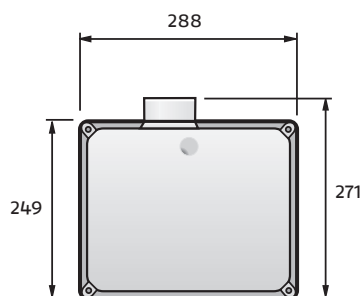

**BIO FUELS**

Riello Burners is able to offer technical variants which allow burners to be used within environmental heating, process or special applications. These applications now include solutions for liquid Bio fuels (i.e. biodiesel and vegetable oil).

Our experience in research and development and field applications with organic origin Bio fuels has resulted in Riello being able to offer a wide range of solutions for the combustion of Bio fuels.

**KEROSENE AND ULSD**

Riello 40 G series burners can be supplied, on demand, suitable for applications where combustion of Kerosene, Low Sulphur Kerosene and Ultra Low Sulphur Diesel Oil (ULSD) is the chosen fuel.

These burner variants can be provided upon request and after a technical-commercial evaluation; for more information please contact Riello Burners Commercial and Technical Department, our Application Engineers will be pleased to help you.

# Specification

## DESIGNATION OF SERIES

A specific index guides your choice of burner from the various models available in the RIELLO 40 G series. Below is a clear and detailed specification description of the product.

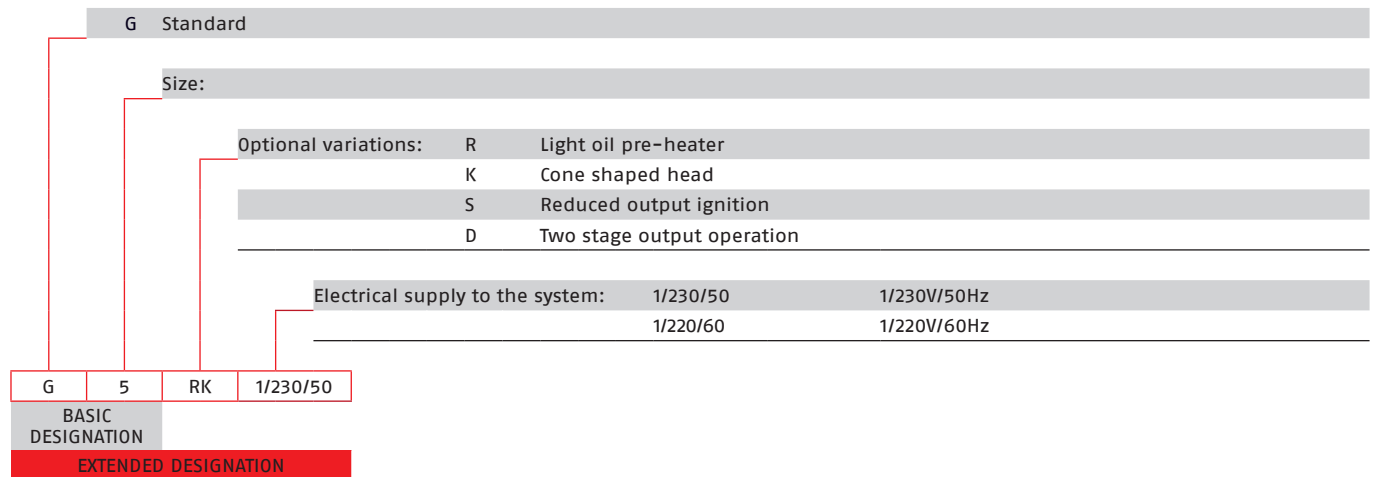

## STATE OF SUPPLY

Completely automatic monobloc light oil burners, one stage operation, made up of:

- Fan with forward curve blades
- Metallic cover lined with sound-proofing material
- Air damper, completely closed in stand by, with adjustment
- Single phase electric motor 230 V, 50 Hz
- Combustion head fitted with:
  - stainless steel head cone, resistant to high temperatures
  - ignition electrodes
  - flame stability disk
- Geared pump for fuel supply, fitted with:
  - filter
  - pressure regulator
  - attachments for fitting a pressure gauge and vacuum meter
  - internal by-pass for preparing for single-pipe installations
- Fuel feed solenoid valve incorporated in the pump
- Photocell for flame detection
- Electronic flame control equipment
- Light oil nozzle
- IP X0D (IP 40) protection level
- Fuel pre-heater (optional)
- Reduced output ignition mechanism (optional).

### Standard equipment:

- Two flexible pipes for connection to the light oil supply line
- Two nipples for connection to the pump
- Flange, screws and nuts for fixing
- Thermal gasket
- 7-pin plug (on request)
- Maintenance assembly
- Instruction handbook for installation, use and maintenance
- Spare parts catalogue.

**AVAILABLE BURNER MODELS**

BURNER MODELS		HEAT OUTPUT		TOTAL ELECTRICAL POWER	CERTIFICATION	NOTE
		(kW)	(Kg/h)	(kW)		
G3	1/230/50	23,8 - 35,5	2 - 3	0,115	CE - 0036 0315/01	
G3R	1/230/50	23,8 - 35,5	2 - 3	0,165	CE - 0036 0315/01	
G3RK	1/230/50	15 - 35	1,3 - 3	0,170	CE - 0036 0254/99	
G5	1/230/50	28 - 60	2,3 - 5	0,130	-	
G5 TL	1/230/50	28 - 60	2,3 - 5	0,130	-	
G5R	1/230/50	28 - 60	2,3 - 5	0,185	-	
G5RK	1/230/50	12 - 60	1 - 5	0,185	CE - 0036 0256/99	
G7	1/230/50	29 - 69	2,5 - 5,8	0,160	-	(1)
G10	1/230/50	54 - 120	4,5 - 10	0,170	CE - 0036 0257/99	
G10	1/220/60	54 - 120	4,5 - 10	0,200	-	
G10 TL	1/220/50	54 - 120	4,5 - 10	0,200	-	
G20	1/230/50	95 - 213	8 - 18	0,320	-	
G20	1/220/60	95 - 213	8 - 18	0,400	-	
G20 TL	1/220/50	95 - 213	8 - 18	0,400	-	
G20S	1/230/50	95 - 240	8 - 20	0,330	-	
G20S	1/220/60	95 - 240	8 - 20	0,410	-	

**MODELS WITH 24V DC ELECTRICAL SUPPLY**

G7	24V DC	29 - 69	2,45 - 5,8	0,3		
G10	24V DC	54 - 120	4,5 - 10	0,3		
G20	24V DC	95 - 201	8 - 17	0,3		

(1) UK version

Net calorific value: 11,8 kWh/kg - 10200 kcal/kg - Viscosity at 20°C: 4÷6 mm<sup>2</sup>/s (cSt)

The burners of G series are in according to EN 267.

**Bio fuels**

Riello Burners is able to offer technical variants which allow burners to be used within environmental heating, process or special applications. These applications now include solutions for liquid Bio fuels (i.e. biodiesel and vegetable oil).

Our experience in research and development and field applications with organic origin Bio fuels has resulted in Riello being able to offer a wide range of solutions for the combustion of Bio fuels.

**Kerosene and ULSD**

Riello 40 G series burners can be supplied, on demand, suitable for applications where combustion of Kerosene, Low Sulphur Kerosene and Ultra Low Sulphur Diesel Oil (ULSD) is the chosen fuel.

These burner variants can be provided upon request and after a technical-commercial evaluation; for more information please contact Riello Burners Commercial and Technical Department, our Application Engineers will be pleased to help you.

**Conforming to:**

- 2014/30/UE directive (electromagnetic compatibility)
- 2014/35/UE directive (low voltage)
- 92/42/EC directive (boiler efficiency)
- 2006/42/EC directive (machine)
- EN 267 (liquid fuel burners)

**Available accessories to be ordered separately:**

- Remote control release kit for 530-531 control boxes
- Extended head kit
- Spacer kit
- Inlet air aspiration kit
- Light oil filter
- Light oil filter/degassing unit
- 7-pin plug kit
- Hour counter kit for 530 SE and 531 SE control boxes
- 7 pole socket kit for 530 SE and 531 SE control boxes.



# Riello Burners a world of experience in every burner we sell.

05/2016

TS0024UK04



[ 1 ]



[ 2 ]

Across the world, Riello sets the standard in reliable and high efficiency burner technology.

With burner capacity from 5 kW to 48 MW, Riello gas, oil, dual fuel and Low Nox burners deliver unbeatable performance across the full range of residential and commercial heating applications, as well as in industrial processes.

With headquarter in Legnago, Italy, Riello has been manufacturing premium quality burners for over 90 year. The manufacturing plant is equipped with the most innovative systems of assembling lines and modern manufacturing cells for a quick and flexible response to the market.

Besides, the Riello Combustion Research Centre, located in Angiari, Italy, represents one of the most modern facility in Europe and one of the most advanced in the world for the development of the combustion technology.

Today, the company's presence on worldwide markets is distinguished by a well-constructed and efficient sales network, alongside many important Training Centres located in various countries to meet its customers' needs. Riello has 13 operational branches abroad (in Europe, America and Asia), with customers in over 60 countries.

[ 1 ] BURNERS PRODUCTION PLANT  
S. PIETRO, LEGNAGO (VERONA) - ITALIA

[ 2 ] HEADQUARTER BURNERS DIVISION  
S. PIETRO, LEGNAGO (VERONA) - ITALIA

RIELLO S.p.A. - 37045 Legnago (VR) - Italy  
tel. +39 0442 630111 - fax: +39 0442 21980  
[www.riello.com](http://www.riello.com)

Since the Company is constantly engaged in the production improvement, the aesthetic and dimensional features, the technical data, the equipment and the accessories can be changed. This document contains confidential and proprietary information of RIELLO S.p.A. Unless authorised, this information shall not be divulged, nor duplicated in whole or in part.

# RIELLO