

Technical Manual of PC1001 (Electric Part)

PHNIX
2017

Project description	Controller info 1.Controller: 35005-310145 V3.6 2.Wire Controller: 35005-310261 V1.1
Document version	
First edition	
Last edition	

Change history

Version	Date	Author	Description
V1.0	2017.04.12	Antonio	

Content

I. Touch screen wire controller interface introduction.....	4
II. The icons' introduction.....	5
1. Icons	5
2. Key.....	6
III. The operation of key	7
1.ON/OFF key	7
2. Switch mode	8
3. Temperature setting	9
4. Advanced user interface.....	10
5. Locked screen	18
6. The setting of factory or customer parameter.....	19
7. The display of compressor, fan and pump.....	25
8. Factory parameter recovery	25
9. Malfunction interface	29
IV. Parameter list of unit	31
V. Error codes and Troubleshooting.....	33
VI. PCB I/O Ports description	35
1. Connection of PCB illustration	35
2. Wiring diagram	37
VII.Description of the parameters	38
D—Defrost parameter.....	38
E—EEV parameter	39
F—Fan parameter.....	39
H—System Parameter.....	40
P—Water pump parameters.....	41
R—Temperature parameter	41
U—Flow parameter	42
0—Condition of load	42
S—Condition of switch.....	43
T—condition of temperature	43
Appendix I	44

I. Touch screen wire controller interface introduction

The heat pump is equipped with a digital control panel with a touch screen, electronically connected and pre-set at the factory in heating mode.

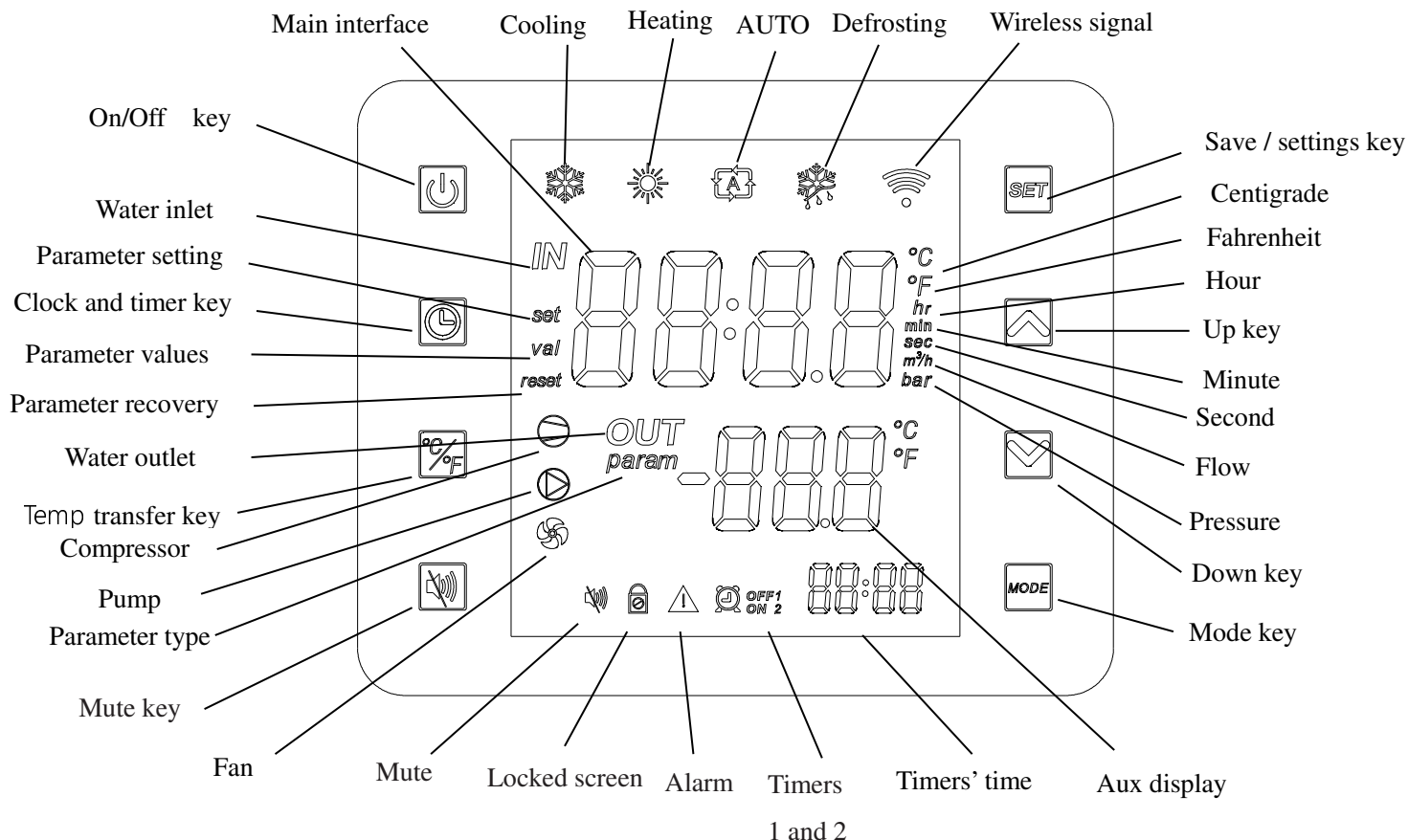

II. The icons' introduction

1. Icons



Cooling mode : display when cooling.



Heating mode : display when heating.



AUTO mode : displaying in automatic mode.



Defrosting symbol : display when the unit is defrosting.



Wireless signal : not used.



Compressor symbol : display when the compressor is running.



Pump symbol : display when the pump is running.



Fan symbol : display when the fan is running. If the fan spin a cycle in 0.25s, it means in high speed. If the fan spin a cycle in 0.5s, it means in low speed.



Parameter setting symbol : display when adjusting the parameter.



Parameter values symbol: display when the main interface shows parameter values.



Parameter recovery symbol : display when the parameters are recovered to factory parameters.



Parameter type symbol : display when the auxiliary interface shows parameter code.



Fahrenheit degree: display when the main interface and auxiliary interface shows Fahrenheit degree.



Centigrade degree: display when the main interface and auxiliary interface shows centigrade degree.



Hour symbol: display when main interface shows hour.



Minute symbol: display when main interface shows minute.



Second symbol: display when main interface shows second.



Flow symbol: display when main interface shows flow.



Pressure symbol: display when main interface shows pressure.



Water inlet symbol: display when main interface shows water inlet temperature.



Water outlet symbol: display when main interface shows water outlet temperature.



Mute symbol: display when starting mute function.

(Only when the software is 35005-310241 and use double speed fan.)

Swimming pool heat pump



Lock symbol: display when the keys are locked.



Fault symbol: display when the unit malfunction.



Timing symbol: display when user use timing function, it can set many timing districts.



Time display area: display the present time. (Display the timing time when setting the timing time)

2. Key



ON/OFF key : Press this key to switch on or off, cancel the present operation, turn back to the last interface



Clock and timer key : setting the time and timing time.



Temp transfer key : Press this key to switch centigrade or Fahrenheit



Mute key : press this key to start the mute function.



Setting key : press this key to set temperature or parameter.



Up key : page up or increase the values.



Down key : page down or decrease the values.



Mode key : press this key to switch the unit's mode.

Note : 1. Without any operation, the screen will be off after 1 min.(The time value is adjustable)

2. When setting the parameter on the screen and press the up or down key ,the reaction time of key is 300ms in the first 5 seconds. After 5 seconds, the reaction time of key is 50ms.

III. The operation of key

1.ON/OFF key

When the unit is off, press 'ON/OFF' key for 0.5 seconds to start it up.

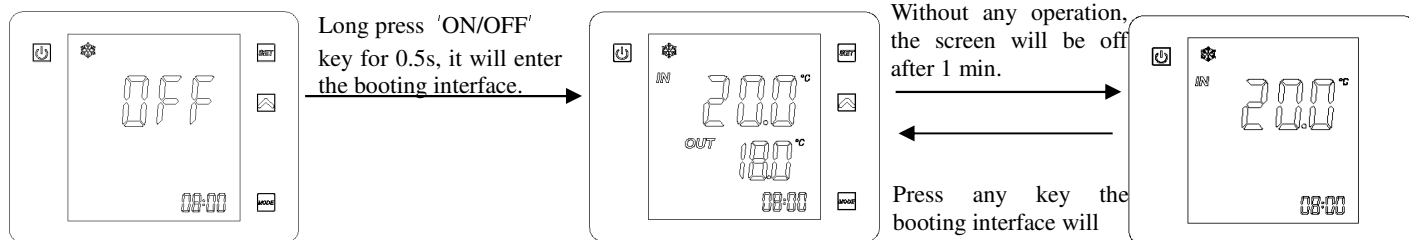

When the unit is on, press 'on/off' key for 0.5 seconds to shut it down.

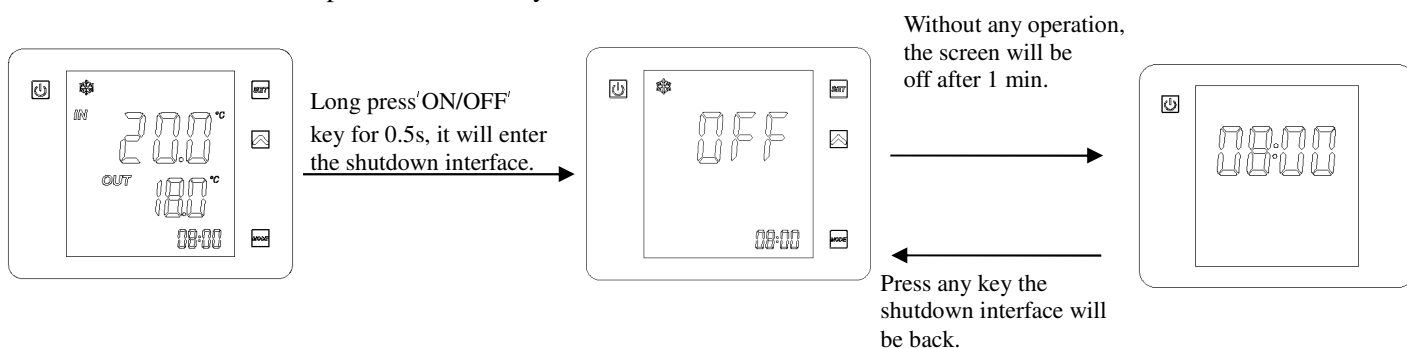

Description of operation :

- 1) On the shutdown interface, you can do any operation as same as on the booting interface.
- 2) You can only operate the on/off key on the main interface.
- 3) When the screen is off, you can press any key to turn back the main interface.

PS: When the unit is running, if the emergency switch shut the unit off , the screen will show that:

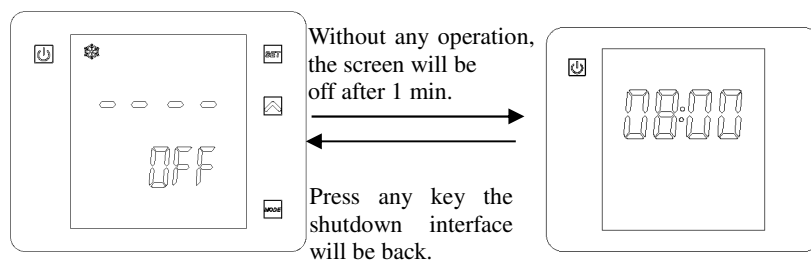

2. Switch mode

Press the 'MODE' to change mode: cooling, heating or automatic.

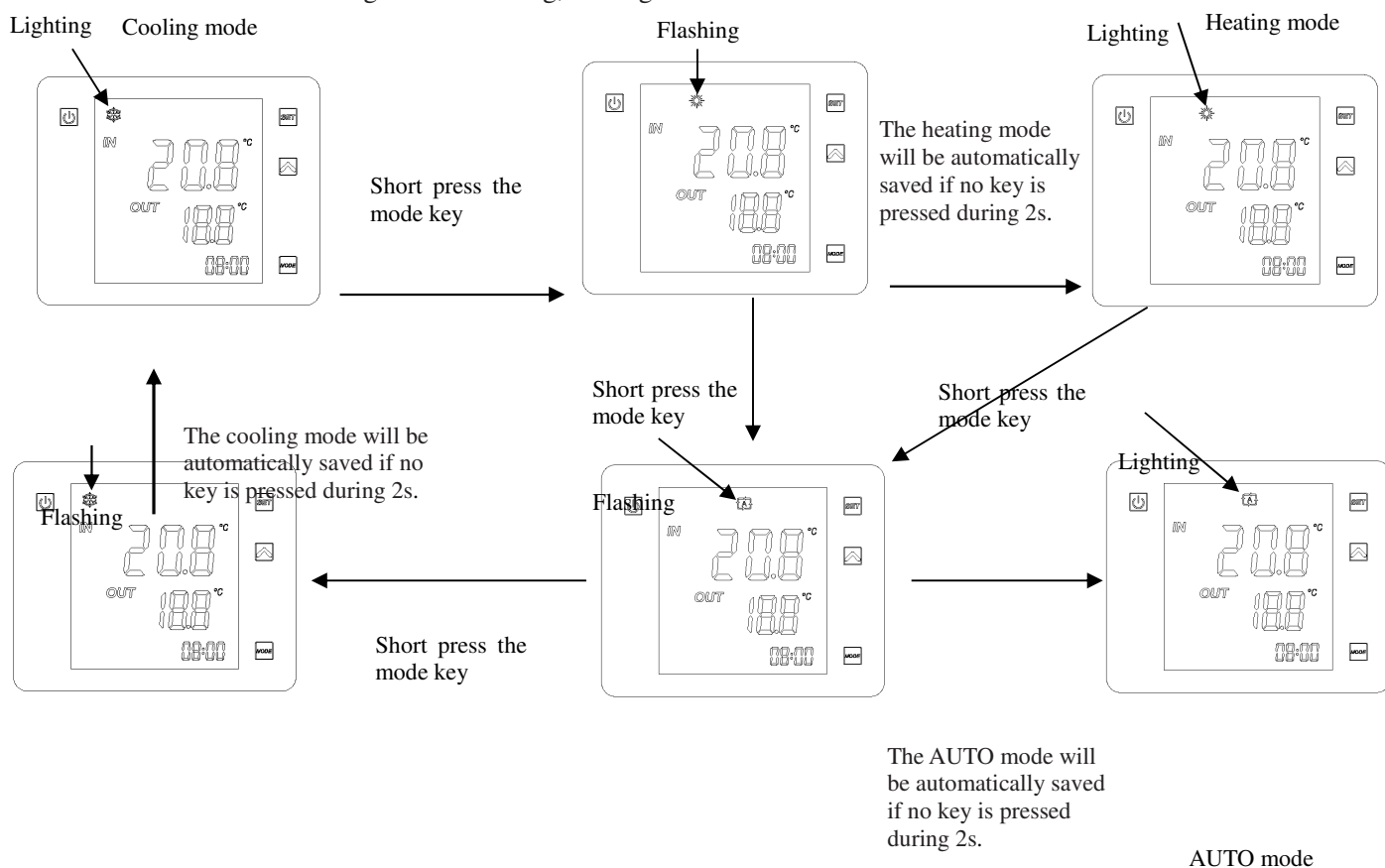

Description of operation :

- 1). When you switch mode, the icon on the screen will flash 2s(The wire controller won't send signal to PCB at that time) . When the icon is lighting on the screen, it means switching mode succeed.
- 2). Switching mode only can be operated on the main interface.

When the unit is defrosting,the defrosting icon will be lighting. It will be off after defrosting end ,and the unit's status will turn back the previous mode(heating/cooling/AUTO) .

For example;if the unit's mode is heating before defrosting:

Defrosting status

Heating mode

Swimming pool heat pump

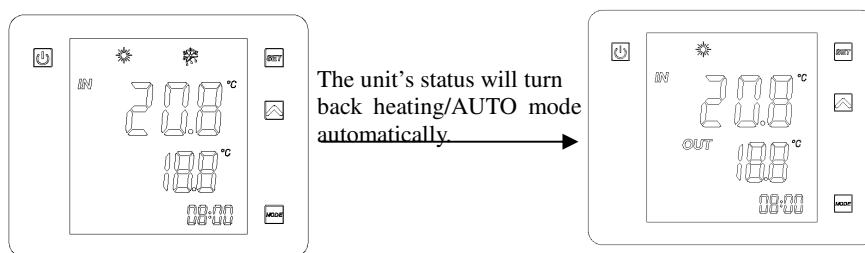

Note: You can switch the mode during the defrosting cycle. After the defrosting ends, the unit will work at new mode.

3. Temperature setting

On the main interface, short press the 'Up key', then it will enter target temperature interface. You can change the target temperature by pressing 'Up' or 'Down' key.

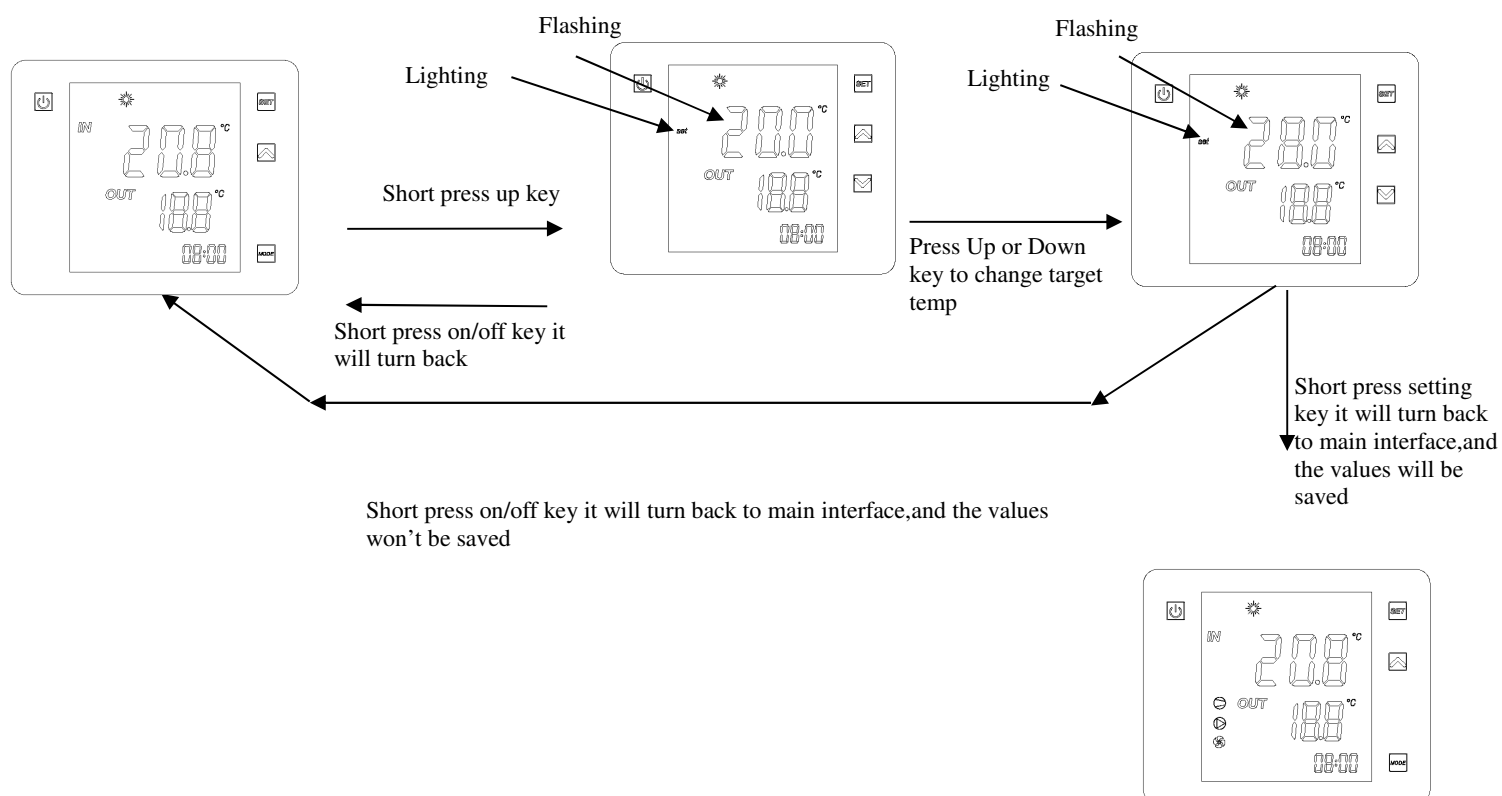

Description of operation :

1) On the temperature setting interface, each time you press the 'up or down' key shortly, the temp will change 0.5°C. (When the degree is Fahrenheit, the changing degree is 1°F).

Swimming pool heat pump

2) On the temperature setting interface, the settings will be automatically saved if no key is pressed during 20s, and it will turn back to main interface.

4. Advanced user interface

a. On the main interface ,you can enter advanced user interface by pressing setting key shortly.

b. On the advanced user interface, you can operate the time setting, temperature adjusting, mute function, timing setting and status checking.

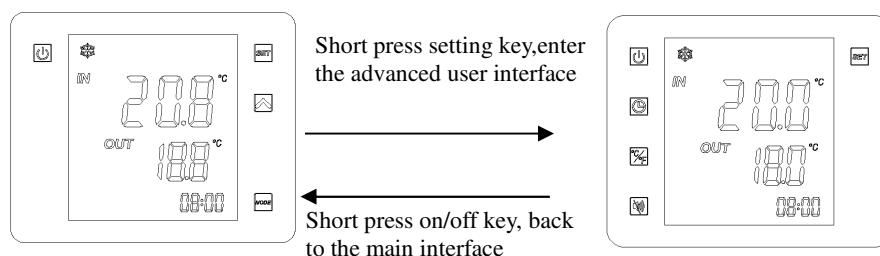

Note: On the main interface, without any operation in 20s, it will turn back to the main interface automatically.

1) Time setting

On the advanced interface, short press the Clock and timer'  'key , it can enter the time setting interface.

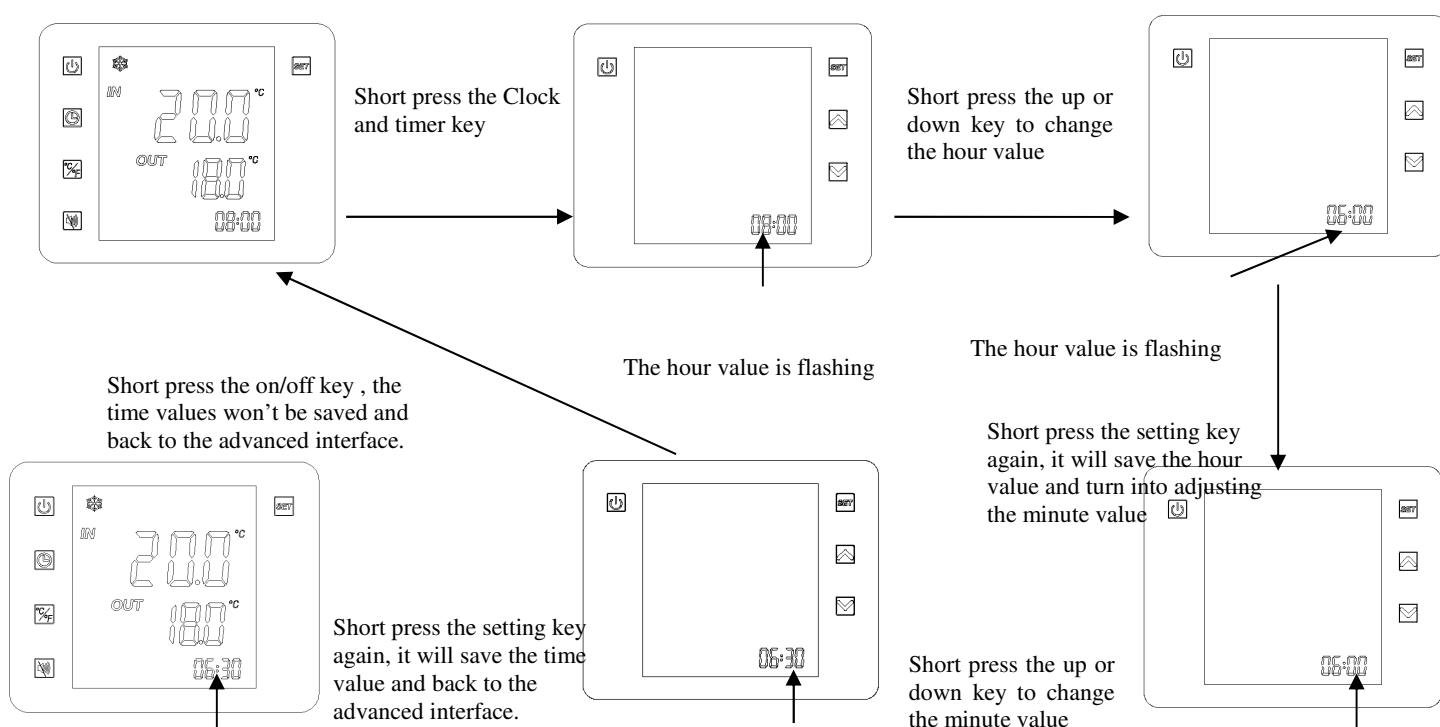

Swimming pool heat pump

Time setting succeed

The minute value is flashing

The minute value is flashing

Note : On the time setting interface, the time values will be automatically saved if no key is pressed during 20s, and the interface will be back to main interface.

2) Temperature adjusting

On the advanced interface, short press the temp transfer '  'key , it can transfer the centigrade to Fahrenheit degree.

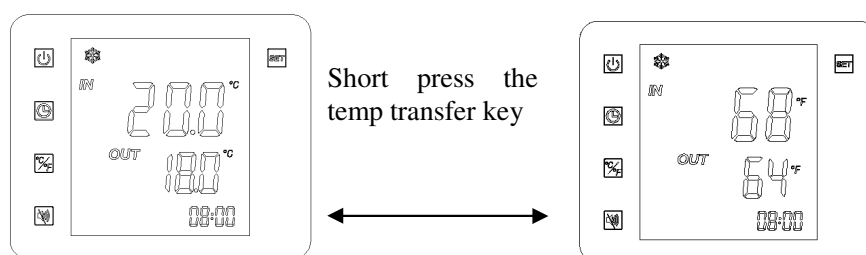

Description of operation :

- 1) When the centigrade degree transfer to Fahrenheit degree, the value only shows integer. It is a round number.
- 2) When the Fahrenheit degree transfer to centigrade degree, the value accuracy is 0.5 °C.
- 3) On the shutdown status, short press the temp transfer key, you can switch the degree unit. (the water outlet temp shows on Fahrenheit or centigrade)

3) Mute function (the controller's software is 35005-310260, 35005-310241 or the fan is double speed)

On the advanced interface, short press the '  ', mute key, it can start or shut down the mute function.

When the unit's fan is double speed, start the mute function, the fan will work at a low speed.

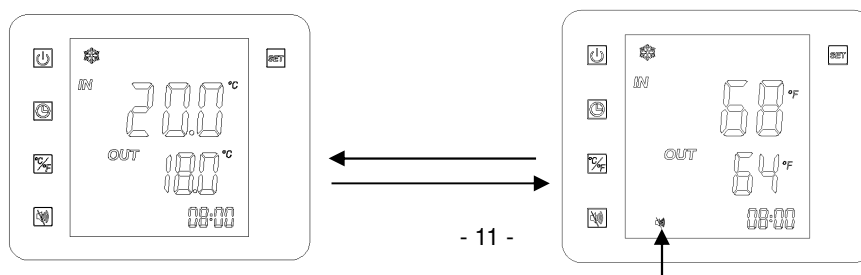

Swimming pool heat pump

Short press the mute key

The mute function is off

The mute function is on

Attention :

- ① When the mute function is on, if the function haven't been relieved within 8 h, the function will be relieved automatically after that time.
- ② If the mute function and timing low speed have been set at the same time, short press the mute key ,the mute function and timing low speed will be canceled at the same time.
- ③ On the shutdown status,short press the mute key, you can start or cancel the function.

4) Timing setting

On the advanced interface,long press the Clock and Timer key for 2s, you can enter the timing setting interface.

(1). Timing start

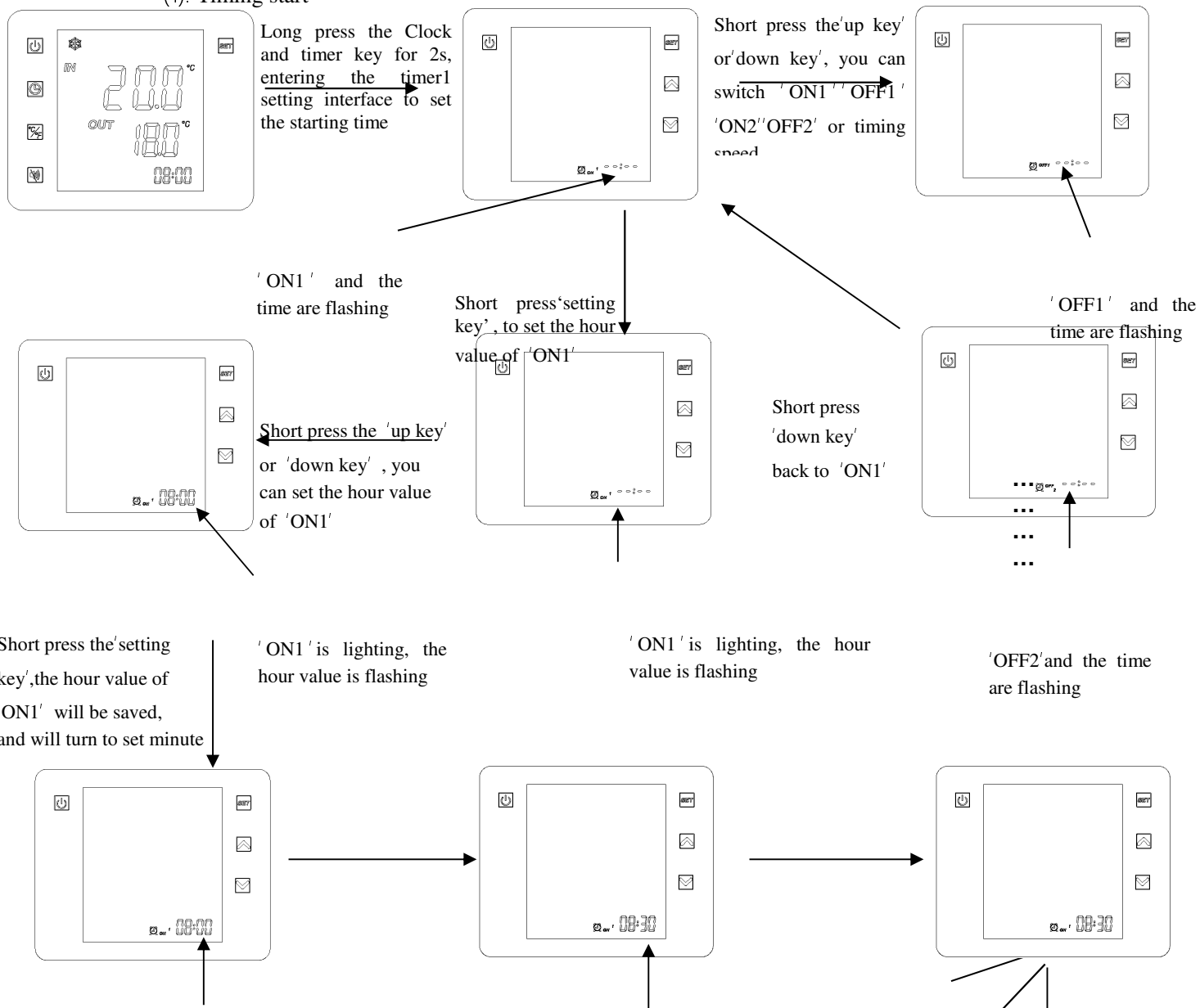

Swimming pool heat pump

Short press the 'up key' or 'down key', you can set the minute value of 'ON1'

Short press the 'setting key', the values of 'ON1' will be saved

'ON1' is lighting, the minute value is flashing

'ON1' is lighting, the minute value is flashing

'ON1' and the time are flashing

Short press the 'ON/OFF key', it will be back to the advanced interface

Short press the 'down key', it will turn to set the value of 'OFF1'

.....

Short press the 'setting key', you can set the timing of 'OFF1' (the setting method is the same as setting 'ON1')

Short press 'setting key', the values of 'OFF1' will be saved

'OFF1' is lighting, the minute value is flashing

Short press the 'down key', it will turn to set the value of 'ON2'

'OFF1' and the time are flashing

Short press the 'setting key', you can set the timing of 'ON2' (the setting method is the same as setting

Short press the 'down key', it will turn to set the value of 'ON2'

.....

'OFF1' and the time are flashing

'ON2' and the time are flashing

Short press 'setting key', the values of 'ON2' will be

'ON2' is lighting, the minute value is flashing

Short press the 'setting key', you can set the timing of 'ON2' (the setting method is the same as setting 'ON1')

Short press the 'down key', it will turn to set the value of 'OFF2'

.....



Short press 'setting key', the values of 'OFF2' will be

'OFF2' is lighting, the minute value is flashing

'OFF2' and the time are flashing

'ON2' and the time are flashing

Swimming pool heat pump

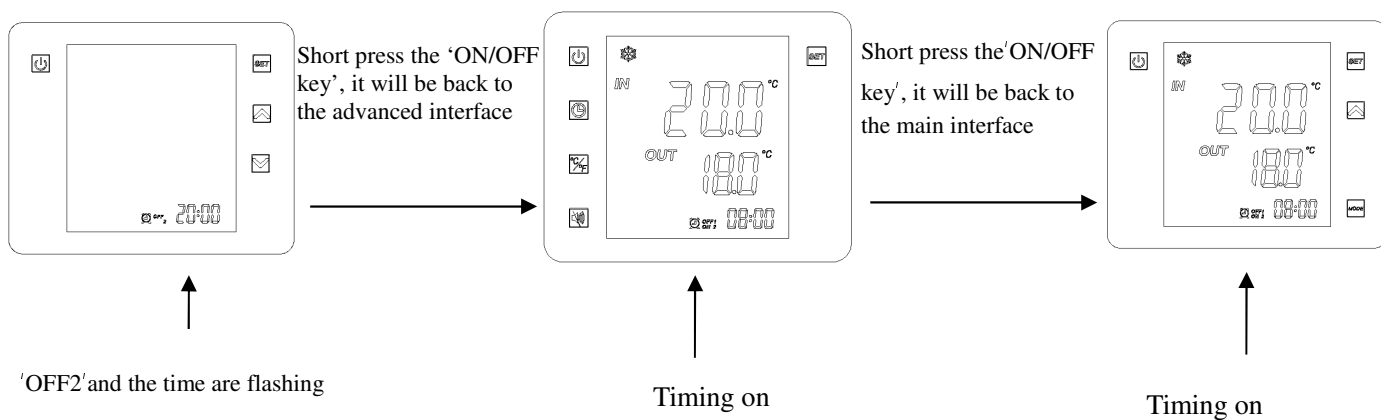

Description of operation :

- ① When you set any district of timing, if the timing icon and time are flashing on the screen at the same time, press the 'ON/OFF key' will turn back to the advanced interface.
- ② During the setting operation, the settings will be automatically saved if no button is pressed during 20s, and the interface will be back to the main interface.
- ③ On the advanced interface, the settings will be automatically saved if no button is pressed during 20s, and the interface will be back to the main interface.
- ④. When setting the value of minute, each time you press the 'up' or 'down' key, the value is 10 min.

(2) Timing low speed setting

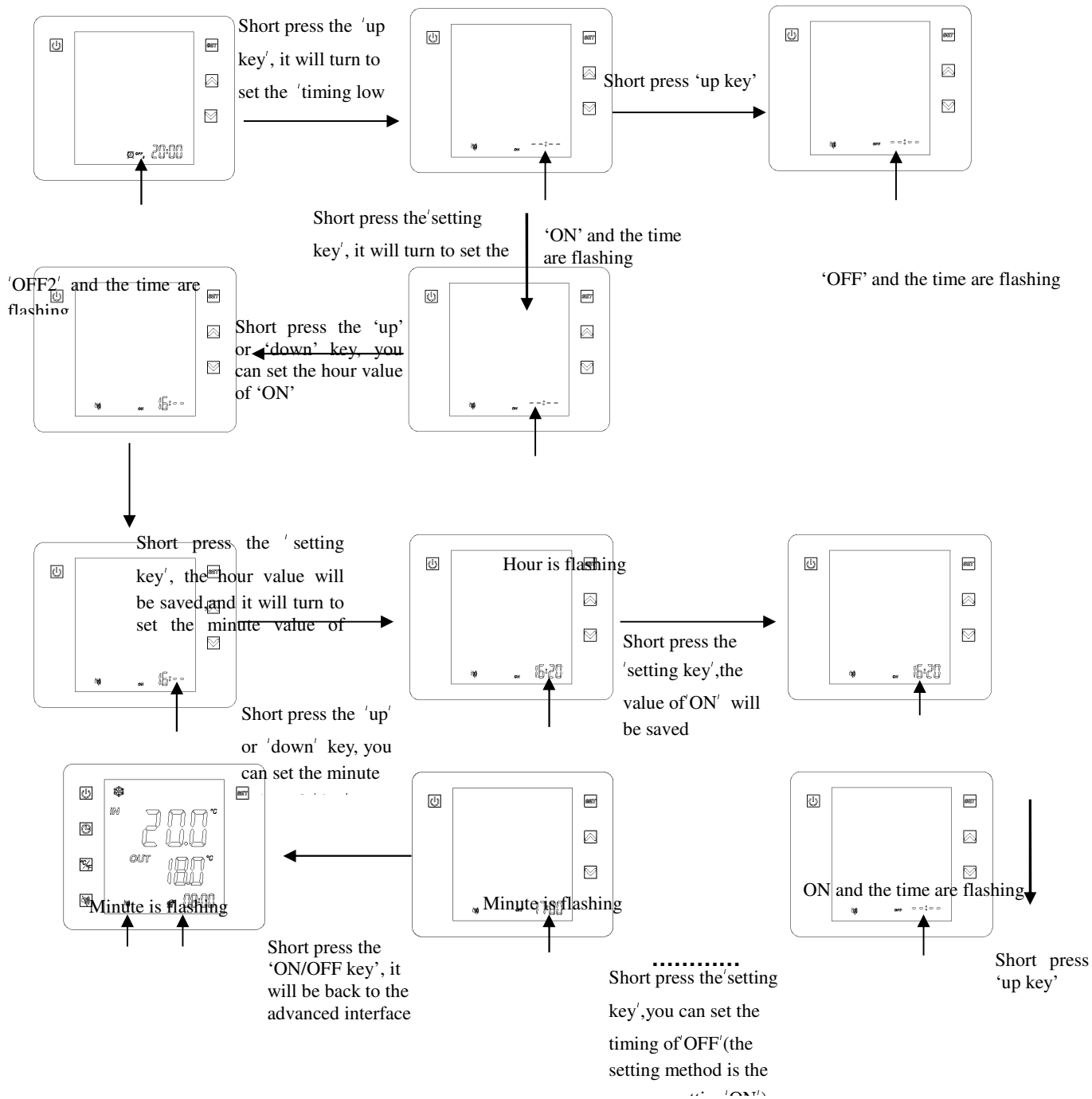

When the mute function is on, the 'ON' and 'OFF' icons will be lighting at the same time

OFF and the time are flashing

OFF and the time are flashing

Attention :

- ① After setting the start time of timing low speed, the shutdown time of timing low speed will follow the default time if the shutdown time didn't set(the shutdown default time is 08:00).
- ② If you haven't set the start time of timing low speed, but you have set the shutdown time of timing low speed, the timing function won't work.

Description of operation :

- ① On the interface, if the timing icon and time values are flashing at the same time, press the 'ON/OFF' key will be back to the advanced interface.
- ② When starting the timing low speed function, the mute icon will be on. When the function is off, the icon will be off too.
- ③ On the setting interface of timing low speed , the settings will be automatically saved if no button is pressed during 20s, and the interface will be back to the main interface.
- ④ When setting the value of minute, each time you press the 'up' or 'down' key ,the value is 10 min.
- ⑤ The method of setting timing low speed is as same as setting timing.

(3) Cancel the timing function

On the timing setting interface, when the values of hour or minute is flashing, short press the 'ON/OFF' key can cancel the timing district. At the same time, when you press the 'setting key' , you can reset the timing.

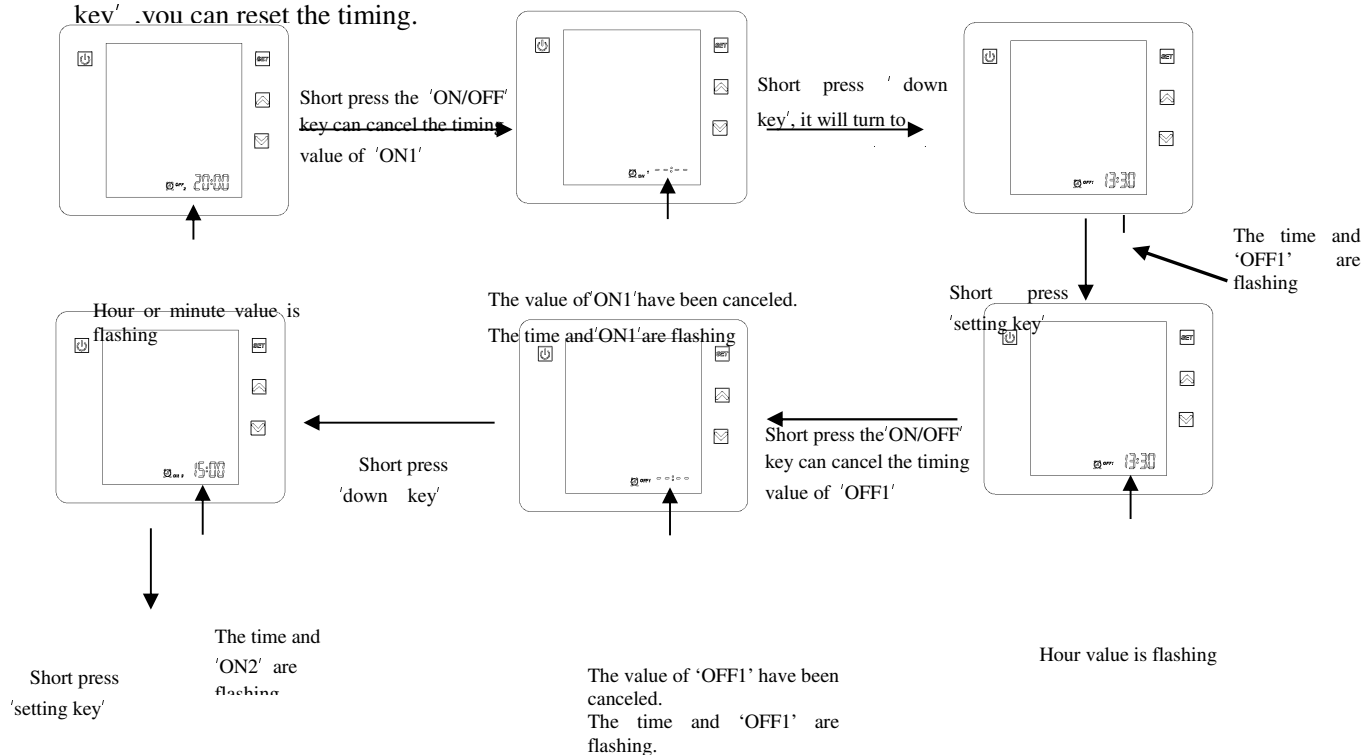

Swimming pool heat pump

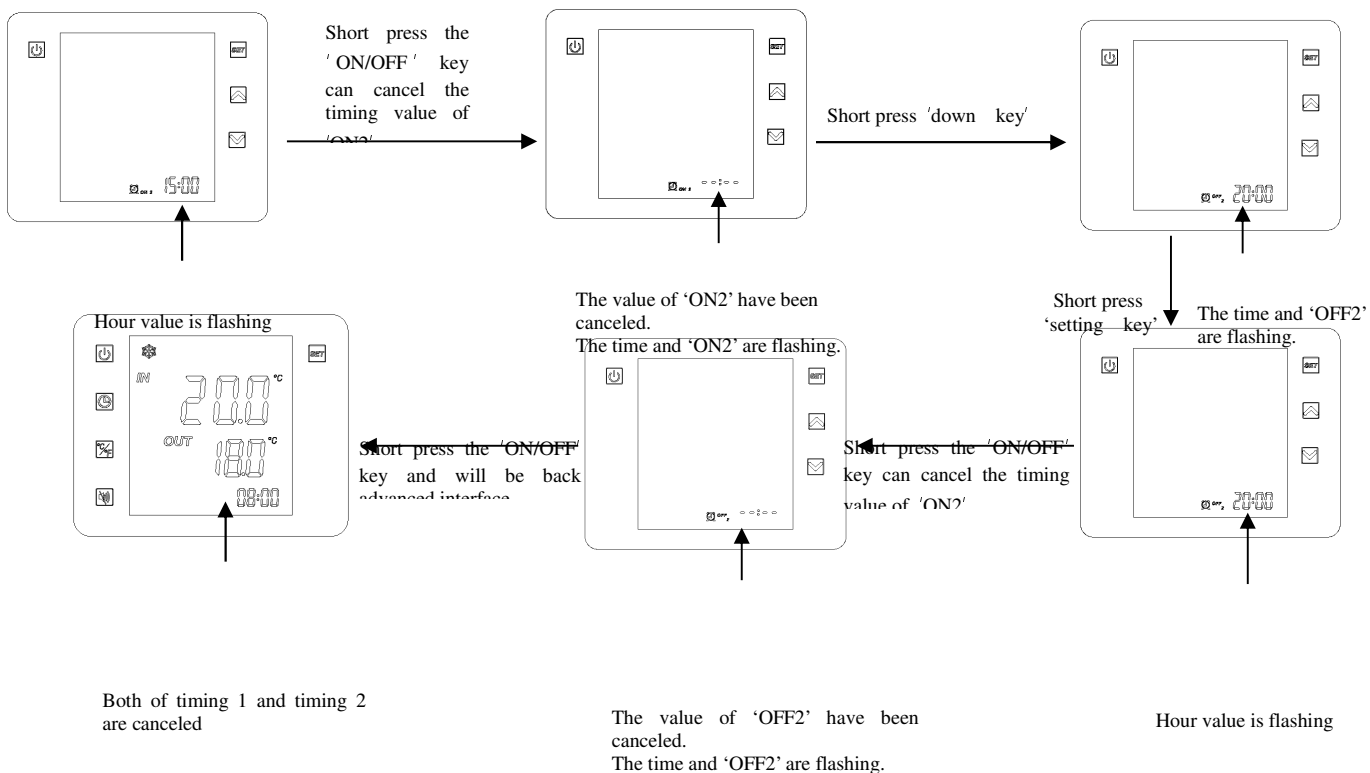

(4) Cancel timing low speed function.

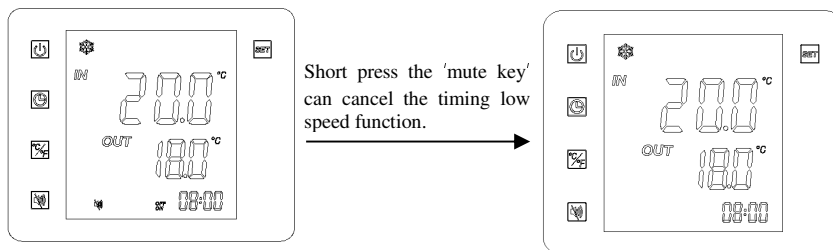

5) Status checking

On the advanced interface, long press the 'temp transfer key' for 2s, it will enter status checking interface.

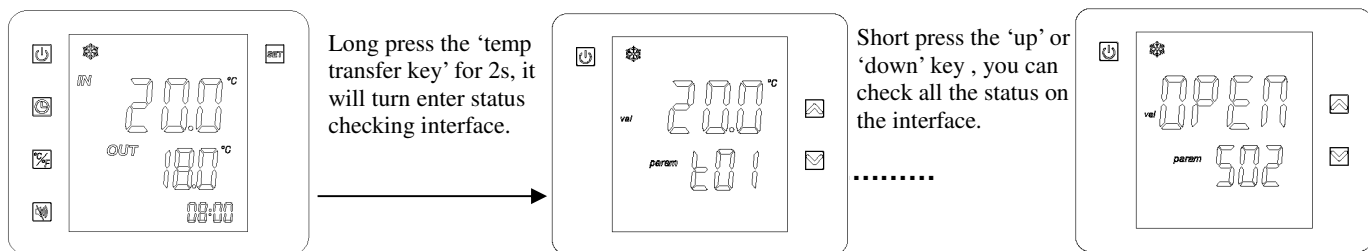

Short press the 'on/off' key, it will be back to the last interface.

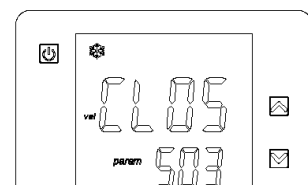

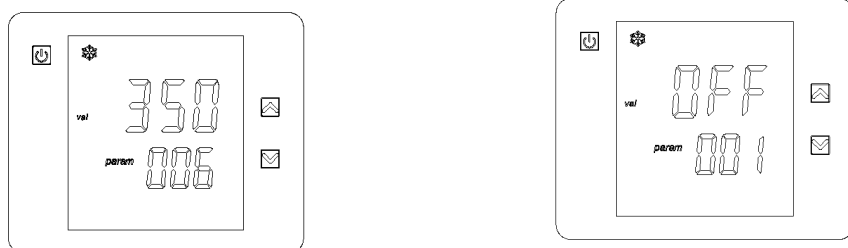

Description of operation :

- (1) On the status checking interface, you can check all the status, and the parameter can't be changed.
- (2) On the status checking interface, you can check 19 parameters, including the suction temp, water inlet temp, water outlet temp, coil temp, ambient temp, exhaust temp, emergency switch, flow switch, pressure switch, mode switch, Master-slave-switch, output of compressor, output of pump, output of 4-way valve, high or low speed output of fan, EEV steps and flow.

(Note : when the parameter E08=1, F11=0 ,the screen will display T06 exhaust temp 2014-12-25)

- (3) On the status checking interface, if you don't press any key, the interface will be still lighting.

5. Locked screen

- 1) On the main interface, long press 'on/off key' for 5s, the screen will be locked.
- 2) On the locked screen, long press 'on/off key' for 5s, the screen will be unlocked.

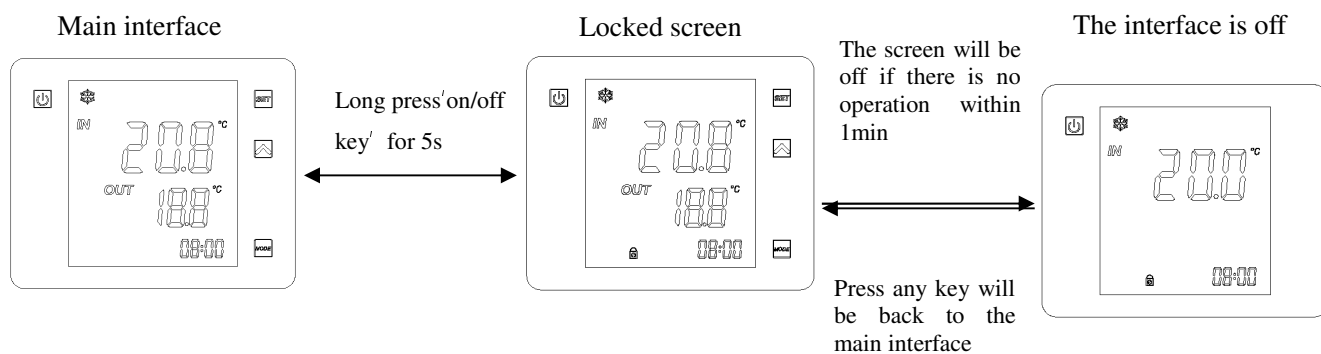

Swimming pool heat pump

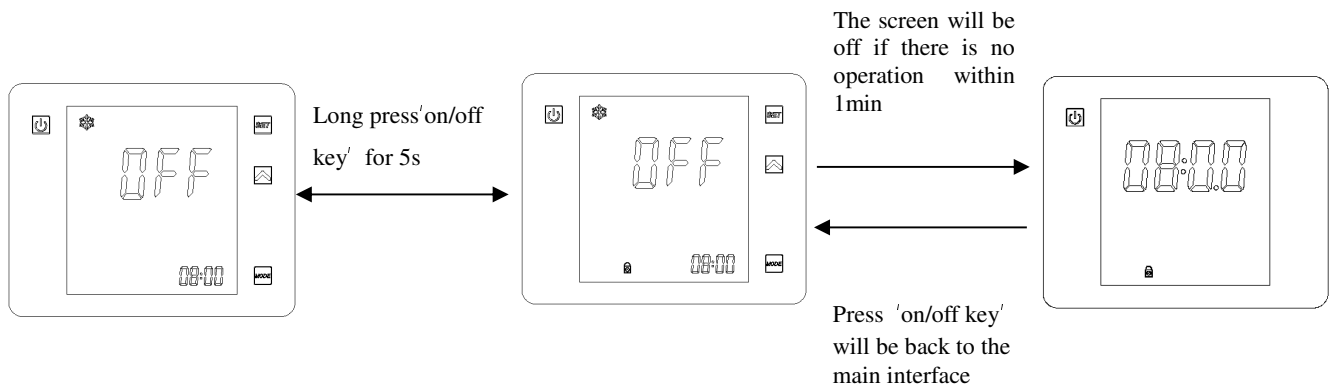

Note :On the locked screen, the 'on/off key' only can be operated to unlock the screen.

6.The setting of factory or customer parameter

Swimming pool heat pump

On the main interface, long press 'mode key' for 10s, it can enter the interface to input passwords.

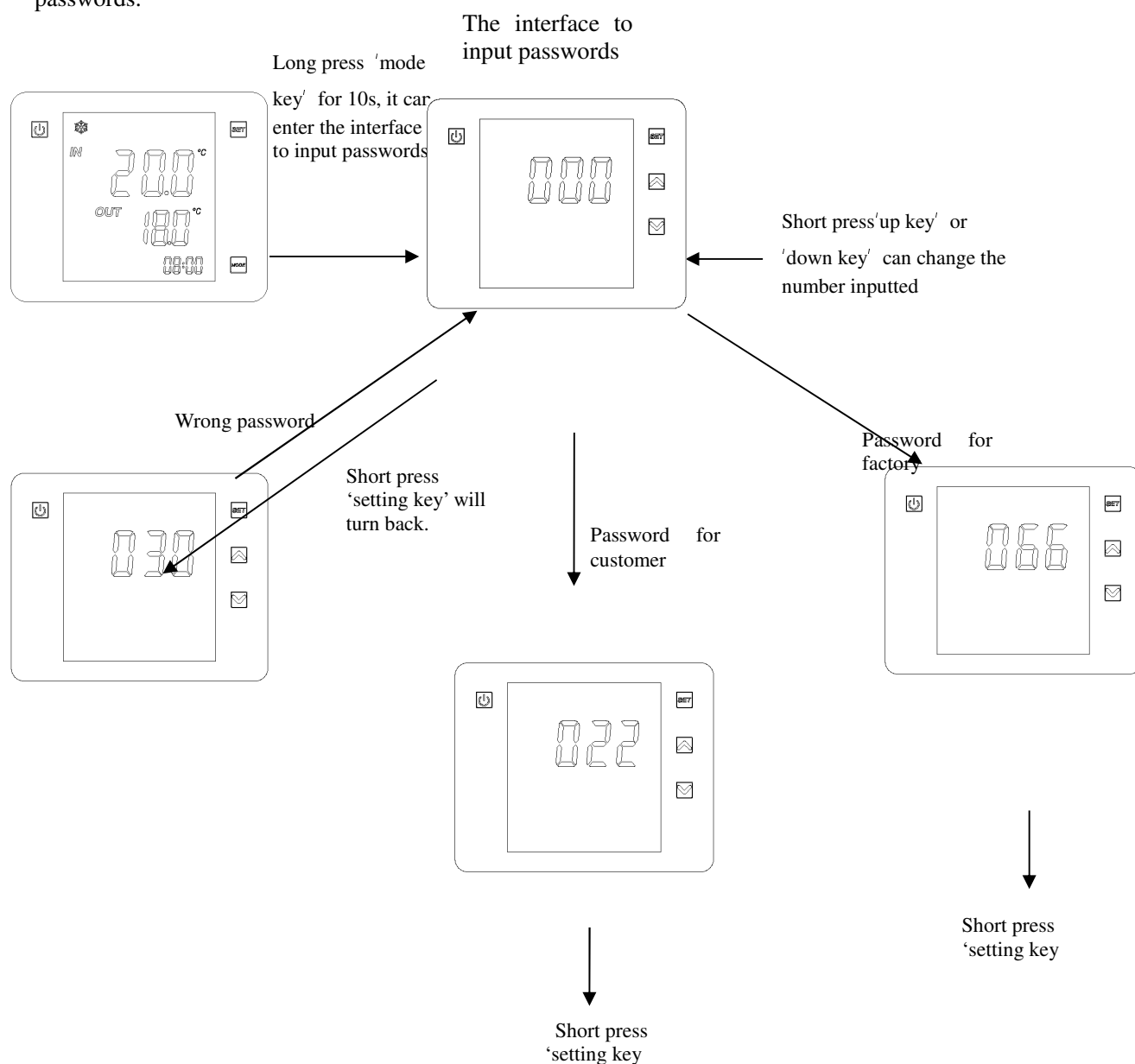

Description of operation :

- (1) On the main interface, long press 'mode key' for 10s, it can enter the interface to input passwords.
- (2) On the interface to input password, you can press 'up' or 'down' key to select 0~999.
- (3) Short press the 'setting key', if you input the password is '022', you will enter the customer setting interface. If you input password is '066', you will enter the factory setting interface. If the password is wrong, it will be back to interface shows '000'. If you short press 'on/off key', it will be back to main interface.

Swimming pool heat pump

(4) The interface will be back to main interface if there is no operation on wire controller within 1min.

1) Customer setting

When the password you input is '022' on the interface, you can enter the customer setting interface(the password is '022', and it can't be changed).

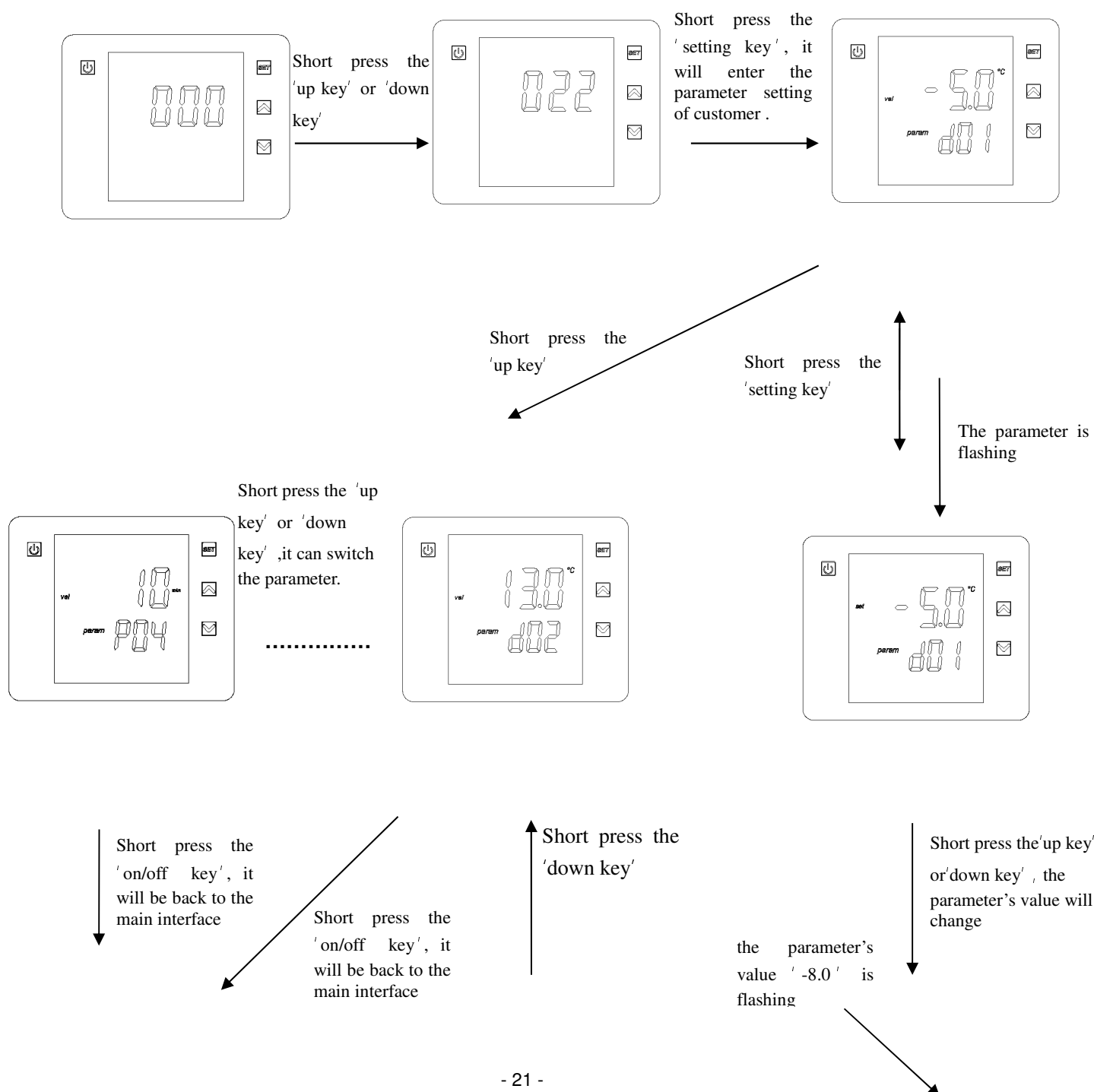

Swimming pool heat pump

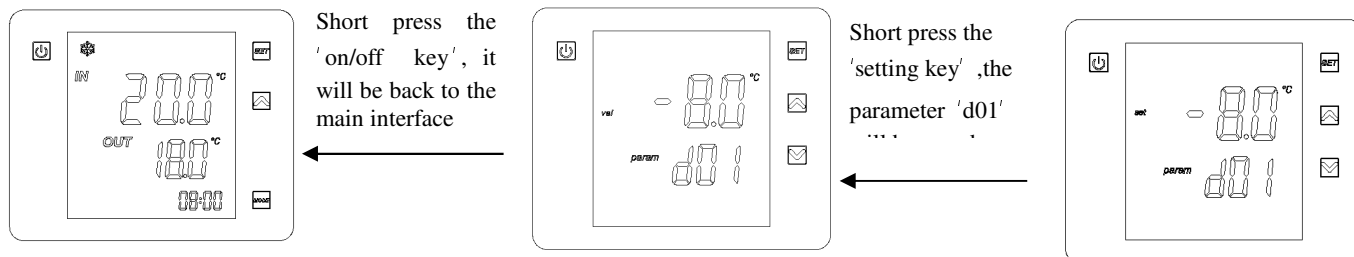

Description of operation :

- (1) On the parameter setting interface of customer, press 'up key' or 'down key', it will display the parameter d01 d02 d03 d04 E01 E03 F01 h02 P01 P02 P03 P04 t01 ~ t05 S01 ~ S06 o01 ~ o07 on the screen.
- (2) Short press the 'setting key', the parameter will be flashing on the main interface, and you can change the value at that time.
- (3) After you finish changing parameter's value, short press the 'setting key', the value won't be flashing again on the interface. The parameter's value will be saved and back to the step 1.
- (4) If you haven't operated following the step 3, but you short press the 'on/off key', the parameter's value won't be saved and back to the step 1.
- (5) When the interface is back to main interface, if you want to check the customer's parameter again, you should press the 'mode key' for 10s, and then input the password '022'.
- (6) On the parameter setting interface of customer, the settings will be automatically saved if no button is pressed during 20s, and the interface will be back to the main interface.

2) Factory setting

When you input the password '066' on the interface, you can enter the factory setting interface(The password is '066', and it can't be changed).

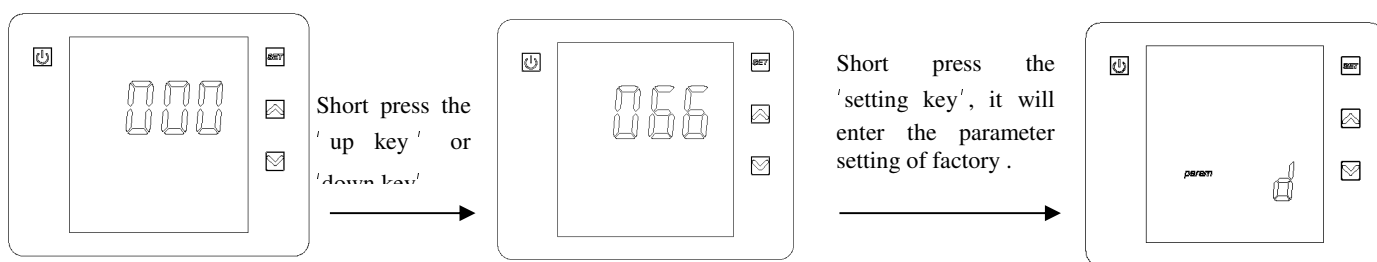

Short press the 'setting key', it will enter the

- ...
- ...
- ... Short press the 'up
- ... key' or 'down
- ... key', the
- parameter's value
- will change

The parameter '-5.0' is flashing

Swimming pool heat pump

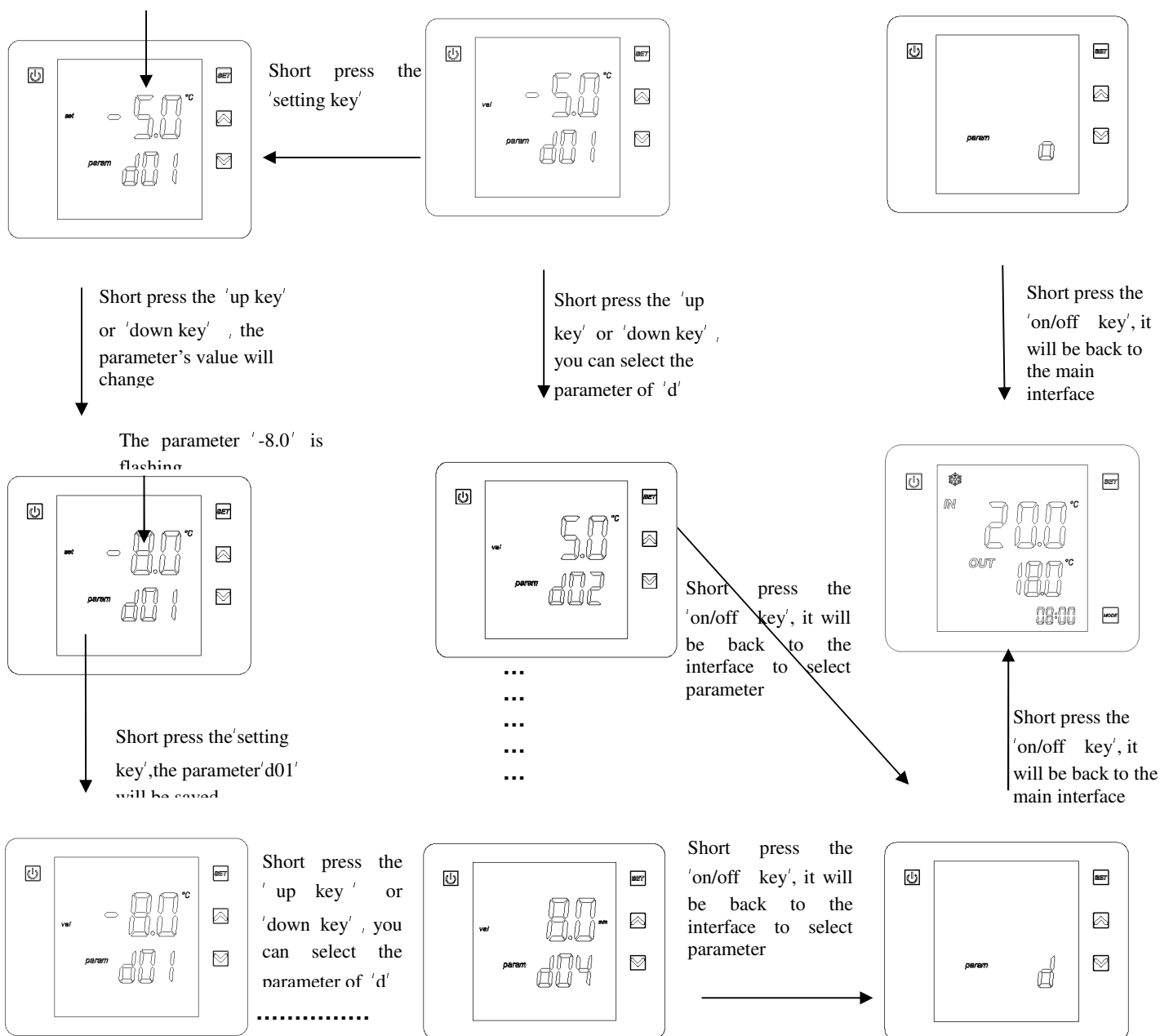

Description of operation :

- (1) On the parameter setting interface of factory, press 'up key' or 'down key', it will display the parameter d E F h P r t S on the auxiliary interface.
- (2) Short press the 'setting key', it will enter the interface of parameter group. You can select the parameter by pressing 'up key' or 'down key'.

Swimming pool heat pump

- (3) After selecting parameter's value,short press the 'setting key', the value won't be flashing again on the auxiliary interface. The parameter's value on the main interface will be flashing ,and you can change the value at that time.(parameter t,S,O haven't step3~5.)
- (4) After changing parameter's value on the main interface,short press the 'setting key', the value won't be flashing again on the main interface. The parameter's value will be saved and back to the step 2.
- (5) If you haven't operated following the step 4,but you short press the 'on/off key', the parameter's value won't be saved and back to the step2.
- (6) On step 2 ,when the parameter group shows on the auxiliary interface,short press the 'on/off key' will turn back to the main interface.
- (7) When the interface is back to main interface, if you want to check the customer's parameter again,you should press the 'mode key' for 10s, and then,input the password '066'.
- (8) On the parameter setting interface of factory, the settings will be automatically saved if no button is pressed during 20s, and the interface will be back to the main interface.

7. The display of compressor, fan and pump

On the main interface,the display of compressor, fan and pump on the screen depend on their working status. When the icons are lighting on the main interface,it means they are working. When the icon is off, it means they are shut.

When the compressor, fan and pump are working , the screen shows:

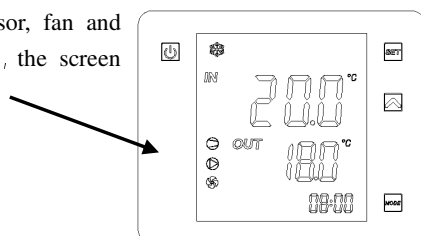

When the compressor, fan and pump are shut , the screen shows:

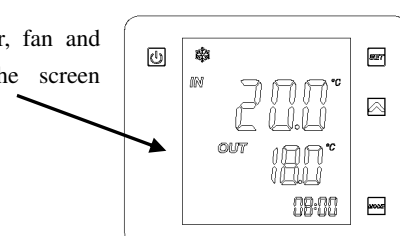

8. Factory parameter recovery

(Note:this software repaired that the parameter values couldn't be uploaded or downloaded when the unit malfunction. 2015-1-6)

Swimming pool heat pump

1) Download parameter (factory parameter recovery)

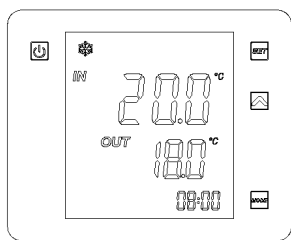

Long press 'setting key' for 10s, entering the interface of factory parameter to recover.

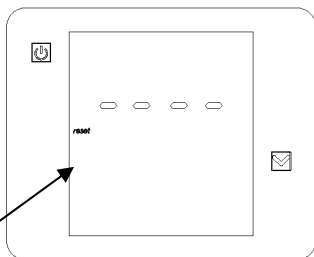

Lighting

Short press 'down key', you can recover the factory parameter

The factory parameter is recovering

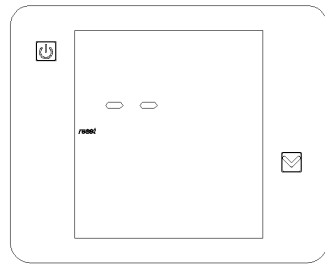
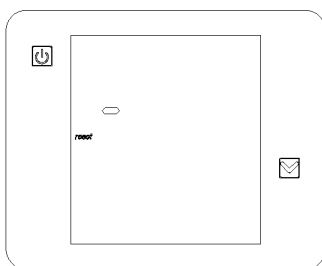

The factory parameter is recovering

Without any operation in 2s or short press 'on/off key', it can return to the main interface.

Short press 'down key', you can recover the factory parameter

The factory parameter is recovering

Short press 'down key', you can recover the factory parameter

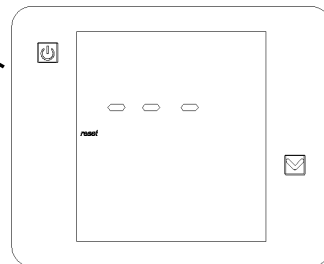
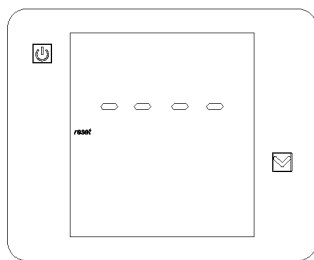

The factory parameter is recovering

Parameter recovery fail

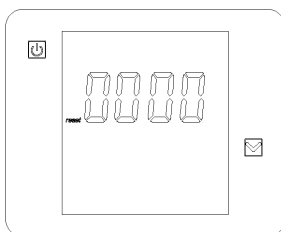
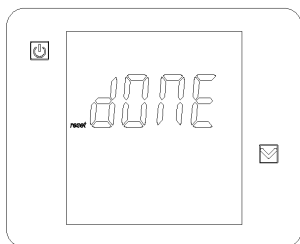

Without any operation in 20s or short press 'on/off key', it can return to the main interface.

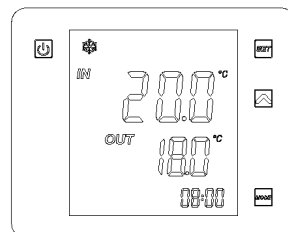

Parameter recovery succeed



Description of operation :

(1) On the main interface, Long press 'setting key' for 10s, entering the interface of factory parameter recovery. At that time, the icon 'reset' will be lighting.

(2) Short press 'down key', it can recover the factory parameter. During the parameters are recovering, short press or long press any key will make no effect. When the parameter recovery succeed, the main interface will show 'dONE'. Without any operation in 2s or short press 'on/off key', it can return to the main interface.

(3) If the parameter recovery fail, the main interface will show '0000'. Without any operation in 20s or short press 'on/off key', it can return to the main interface.

(4) If you want to recover the parameter again, you can short press the 'down key' again, and it will enter the interface to recover factory parameter.

Swimming pool heat pump

2) Upload parameter

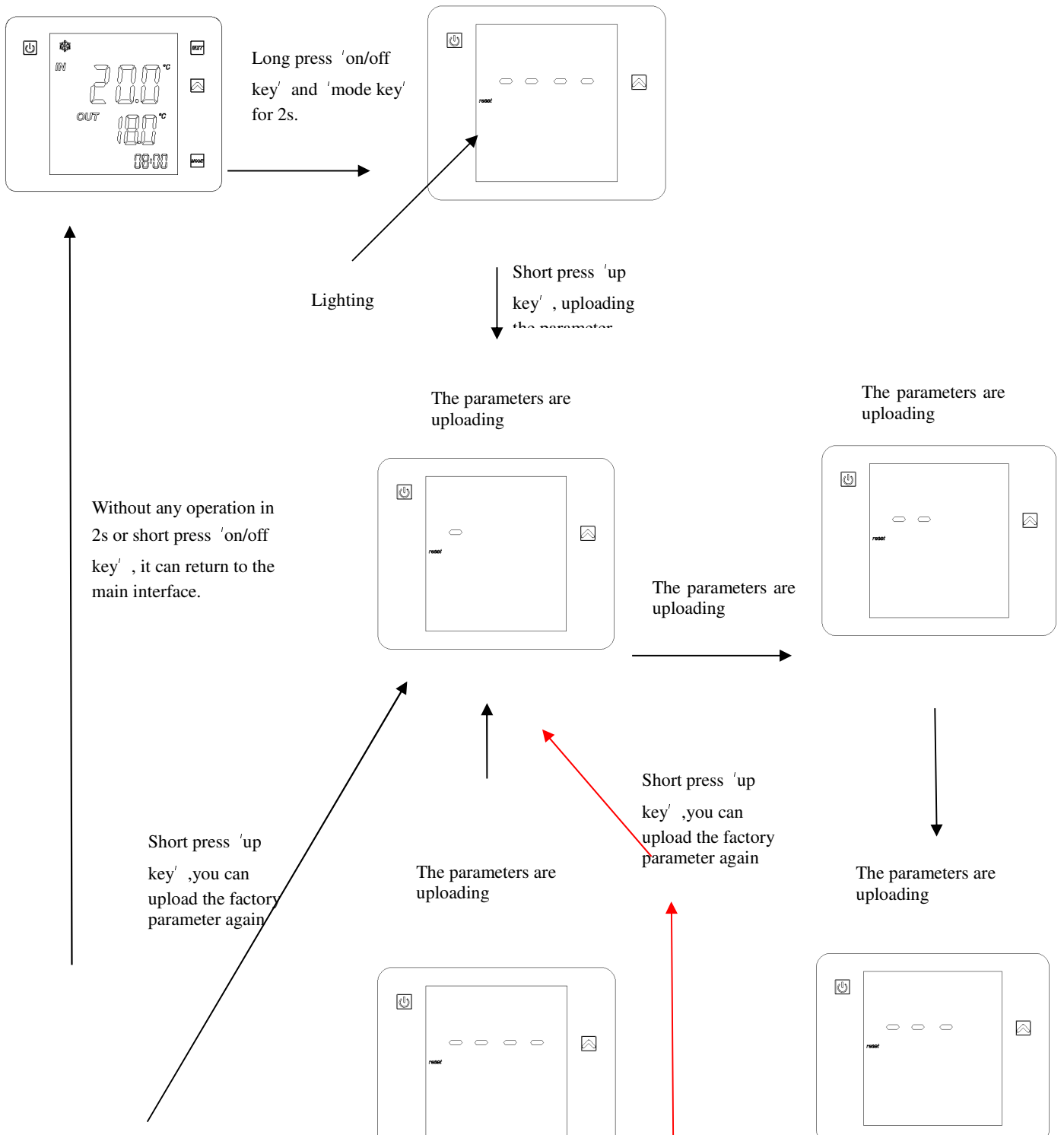

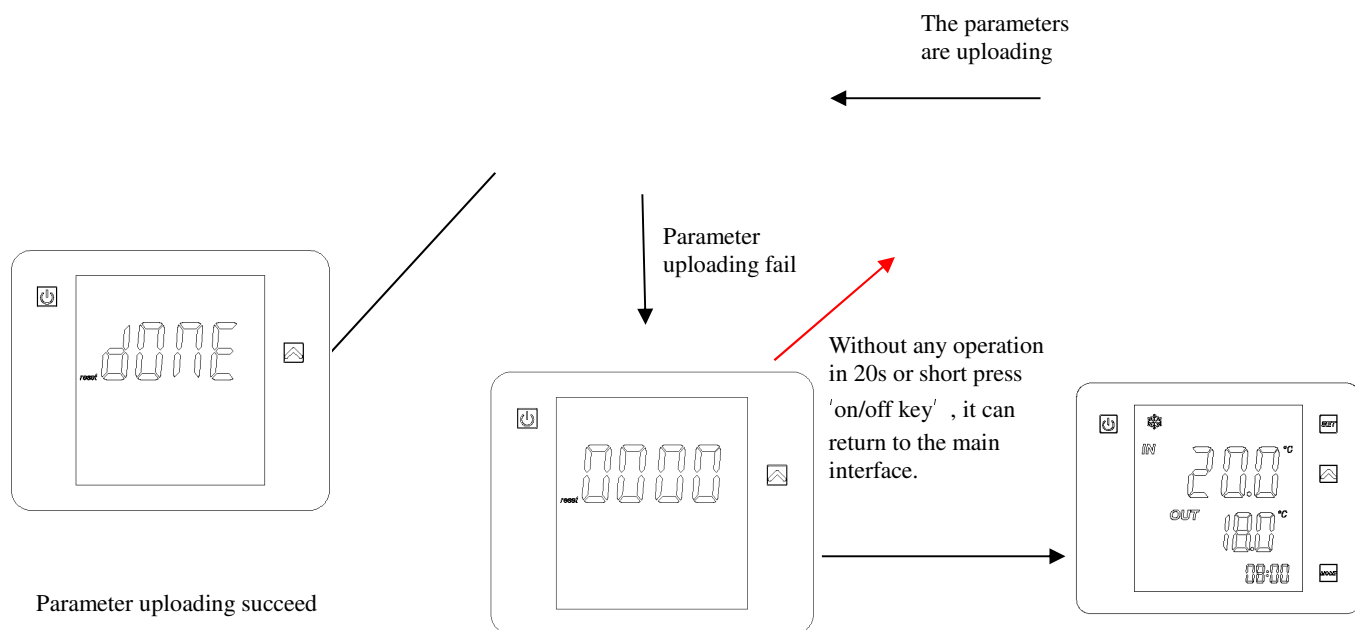

Description of operation :

(1) On the main interface, Long press 'on/off key' and 'mode key' for 2s, entering the interface of factory parameter to upload. At that time, the icon 'reset' will be lighting.

(2) Short press 'up key', it can upload the factory parameter. During the parameters are uploading, short press or long press any key will make no effect. When the parameter uploading succeed, the main interface will show 'done'. Without any operation in 2s or short press 'on/off key', it can return to the main interface.

(3) If the parameter uploading fail, the main interface will show '0000'. Without any operation in 20s or short press 'on/off key', it can return to the main interface.

(4) If you want to upload the parameter again, you can short press the 'up key' again, and it will enter the interface to upload factory parameter.

9. Malfunction interface

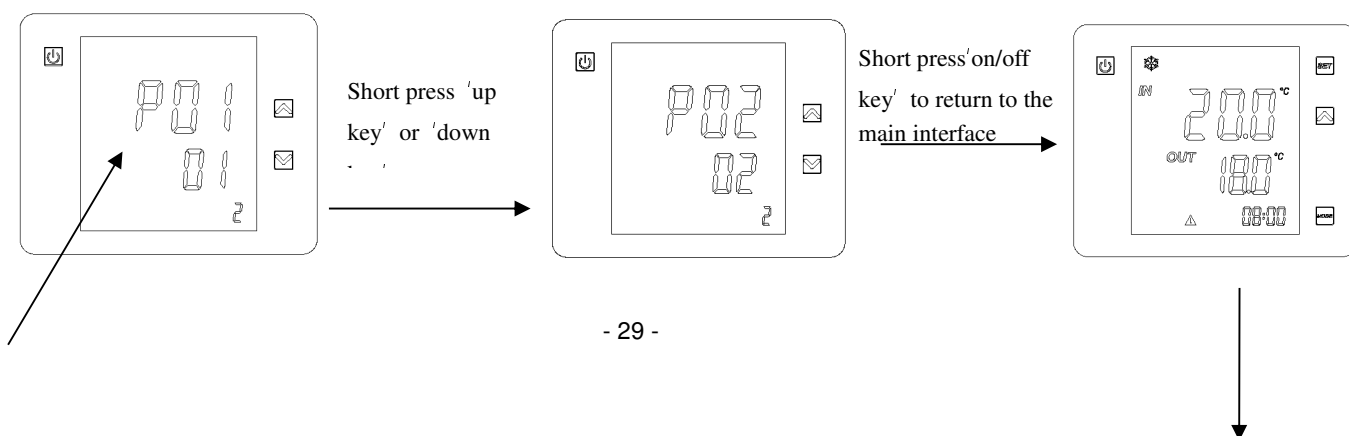

Swimming pool heat pump

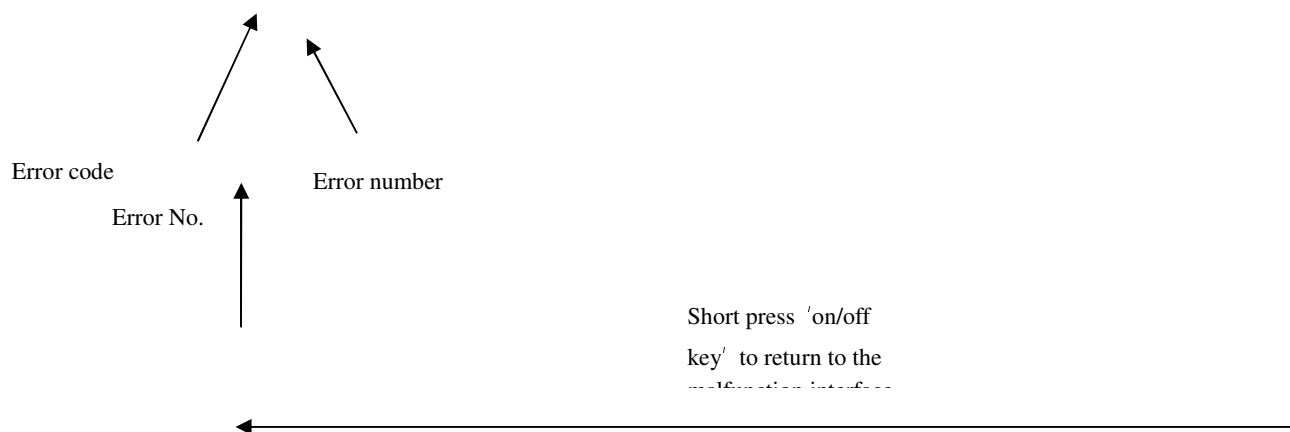

Description of operation :

- (1) On the malfunction interface, short press 'on/off key', it can return to the main interface, and you can do any operation on the main interface.
- (2) On the malfunction interface, short press 'up key' or 'down key', the fault code can display in a cycle on the screen.
- (3) On the main interface, short press 'on/off key', it can return to malfunction interface. Without any operation in 20s, it can also return to the malfunction interface.
- (4) On the locked screen, it will unlock the screen automatically when the malfunction take place. After clearing the malfunction, you need to lock the screen again.
- (5) When the unit malfunction, the screen will be lighting till the fault disappear.
- (6) The warning icon only shows when the unit malfunction.

3). Manually recover malfunction

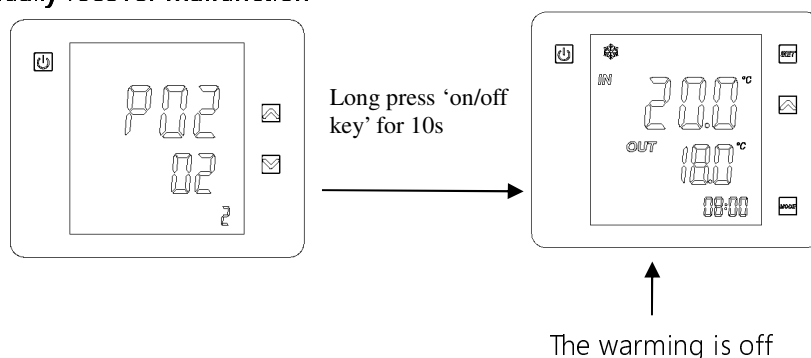

Description of operation :

On the malfunction interface, long press 'on/off key' for 10s, you can recover the malfunction manually. (If the malfunction haven't recovered, most of the malfunctions can't be recovered manually. Refer to the specification of the controller)

IV. Parameter list of unit

parameter	meanings	range	level
d	Parameters of defrost		
d01	Start defrosting temperature	-30~0°C	customer
d02	End defrost temperature	0~30°C	customer
d03	Defrosting cycle	1~90Min	customer
d04	Maximum defrosting time	1~20 Min	customer
d05	Minimum economy defrosting time	1~20 Min	factory
d06	Defrosting mode (0-normal/1-economy)	0~1	factory
E	Parameters of EEV		
E01	EEV mode(0-manual/1-automatic)	0~1	customer
E02	Target super heat	-20~20°C	factory
E03	Initial opening	0~500N	customer
E04	The minimum opening	0~500N	factory
E05	Defrosting opening	0~500N	factory
E06	Cooling opening	0~500N	factory
E07	The setting temperature of exhaust temperature	40~120°C	factory
E08	Whether the exhaust temp is on or off to control the EEV as a auxiliary condition(0-off/1-on)	0~1	factory
F	Parameters of fan		
F01	Parameters of fan motor (0-low speed mode/ 1-high speed mode / 2-ambient / 3-time/ 4=2+3)	0~4	customer
F02	The coil temperature of fan in high speed mode when cooling	-15~60°C	factory
F03	The coil temperature of fan in low speed mode when cooling	-15~60°C	factory
F04	The coil temperature of fan stop when cooling	-15~60°C	factory
F05	The coil temperature(ambient temperature) of fan in high speed mode when heating	-15~60°C	factory
F06	The coil temperature(ambient temperature) of fan in low speed mode when heating	-15~60°C	factory
F07	The coil temperature(ambient temperature) of fan stop when heating	-15~60°C	factory
F08	The start time for silent running mode timing	0~23h	factory
F09	The end time for silent running mode timing	0~23h	factory
F10	Fan speed regulating temp selection (0-coil	0~1	factory

Swimming pool heat pump

	temp/1-ambient temp)		
F11	Speed control module is on or off(0-on/1-off)	0~1	factory
F12	Minimum voltage of fan limit	0%~F13	factory
F13	Maximum voltage of fan limit	F12~100%	factory
h	System and system protection parameter		
h01	If with disable automatic restart (0-no/1-yes)	0~1	factory
h02	Mode (0-cooling mode only/1-automatic heating and cooling modes/2-heating mode only	0~2	customer
h03	Temperature unit (0-【°C】/1-【°F】)	0~1	factory
h04	The minimum frequency of compressor in heating	-20~15°C	factory
P	Parameter of water pump		
P01	Operating mode of water pumps (0-Normal/1-Special/2-Interval)	0~2	customer
P02	Operating time interval of water pumps	0~120min	customer
P03	Operating duration of water pumps	0~30min	customer
P04	Advanced water pump run time of compressors	0~30min	customer
r	Parameter of temperature		
r01	The setting value of water inlet temp in cooling	R08~R09	customer
r02	The setting value of water inlet temp in heating	R10~R11	customer
r03	Target setting temperature for automatic mode	R08~R11	customer
r04	The return difference for cooling unit	0~10°C	factory
r05	Shutdown temp difference at constant temp when cooling	0~10°C	factory
r06	The return difference for heating unit	0~10°C	factory
r07	Shutdown temp difference at constant temp when heating	0~10°C	factory
r08	Minimum cooling set point	-30~R09°C	factory
r09	Maximum cooling set point	R08~80°C	factory
r10	Minimum heating set point	-30~R11°C	factory
r11	Maximum heating set point	R10~80°C	factory
U	Parameters of water flow		
U01	The flow meter is on or off(0-off/1-on)	0~1	factory
U02	The pulse number of flow gauge in 1L water	0~300	factory
T	Condition of temperature		
t01	Suction temperature	-30~97°C	customer
t02	Inlet water temperature	-30~97°C	customer
t03	Outlet water temperature	-30~97°C	customer

Swimming pool heat pump

t04	Coil temperature	-30~97°C	customer
t05	Ambient temperature	-30~97°C	customer
t06	Exhaust temperature	40~120°C	customer
S	Condition of switch		
S01	Emergency switch	CLOS/OPEN	customer
S02	Water flow switch	CLOS/OPEN	customer
S03	LP switch	CLOS/OPEN	customer
S04	HP switch	CLOS/OPEN	customer
S05	Mode switch	CLOS/OPEN	customer
S06	Master-slave switch	CLOS/OPEN	customer
O	Condition of load		
O01	Compressor output	ON/OFF	customer
O02	Circulation water pump output	ON/OFF	customer
O03	4-way valve output	ON/OFF	customer
O04	Fan motor high speed output	ON/OFF	customer
O05	Fan motor low speed output	ON/OFF	customer
O06	EEV output	0~500	customer
O07	Water flow	0.0~65.9m ³ /h	customer

V. Error codes and Troubleshooting

There will be malfunction code showing on the controller screen when relative malfunction occurs.

Code	Failure	Reason	Solution
P01	Water inlet temp. sensor failure	Temp. Sensor is broken	Detect the connection and measure the resistance of sensor, if it's lower than 100Ω or higher than 500kΩ, please replace a new one.
P02	Water outlet temp. sensor failure	Temp. Sensor is broken	
P04	Ambient temp. sensor failure	Temp. Sensor is broken	
P05	Coil temp. sensor failure	Temp. Sensor is broken	
P07	Suction temp. sensor 1 failure	Temp. Sensor is broken	
P08	Exhaust temp. sensor failure (When the parameter E08=1 and F11=0, it will detect the exhaust temp)	Temp. Sensor is broken	

Swimming pool heat pump

E01	High pressure protection (HP)	HP switch is broken	<p>Measure the pressure value when heat pump is running, if it's higher than 42.0 bar, it means heat pump has got really high pressure protection:</p> <ol style="list-style-type: none"> 1. Detect EEV step, low pressure and suction temp. 2. Detect the inlet/outlet water temp whether it's too high. 3. Maybe there is some air in the refrigerant system or the refrigerant is too much. 4. Detect the the flow of pump and the speed of fan. 5. Detect the connection of cables.
E02	Low pressure protection (LP)	LP switch is broken	<p>Measure the pressure value when heat pump is running, if it's lower than 1.5 bar, it means heat pump has got really low pressure protection:</p> <ol style="list-style-type: none"> 1. Detect EEV step, low pressure and suction temp. 2. Detect the inlet/outlet water temp. 3. Detect the leakage in the refrigeration system. 4. Detect the connection of cables. 5. Detect the ambient temp, whether the ambient temp is on the minimum heating area.
E03	Water flow protection	Flow switch is broken	<ol style="list-style-type: none"> 1. Detect the connection of cables. 2. Detect the flow switch. 3. Detect the water valve is opened or opened fully. 4. Detect the water pump and the filter. 5. Maybe there is some air in the water route.
E06	Temp. Difference between inlet and outlet	Temp. Difference $\geq 13^{\circ}\text{C}$	<ol style="list-style-type: none"> 1. Check the water flow. 2. Check the circulation pump. 3. Check the inlet and outlet water sensor. 4. Maybe there is block or some air in the water route.
E07	Antifreeze protection	Water outlet temp. $= < 4^{\circ}\text{C}$	<ol style="list-style-type: none"> 1. Check the water flow. 2. Check the outlet water sensor. 3. Measure the ambient temp. 4. Detect the connection of cables. 5. Check the record of defrosting, whether the defrosting time is too long or too often.

Swimming pool heat pump

E19	Primary Antifreeze protection	Water inlet temp is in the range between 2°C and 4°C, and the ambient temp.= <0°C at the same time.	It is the protection in winter. Once the water temperature rises up to 8 °C or the ambient temp is higher than 1 °C, the error code disappears.
E29	Secondary Antifreeze protection	Water inlet temp is less than 2°C, and the ambient temp.= <0°C at the same time.	It is the protection in winter. Once the water temperature rises up to 15°C or the ambient temp is higher than 1 °C , the error code disappears.
E08	Communication failure	Communication failure between wire controller and main board	1. Check the connection between wire controller and main board. 2. Check the cable's order on the wire controller and main board.

VI. PCB I/O Ports description

1. Connection of PCB illustration

Swimming pool heat pump

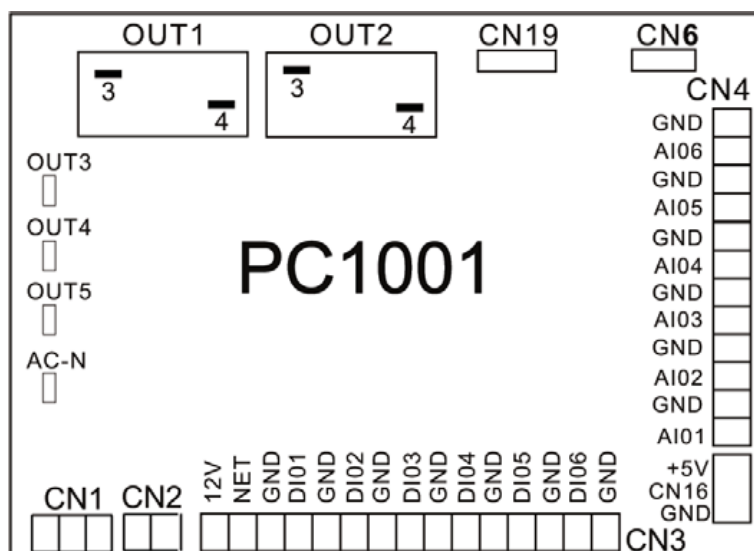

No.	Symbol	Meaning
1	OUT1	Compressor of system1 (220-230VAC)
2	OUT2	Water pump (220-230VAC)
3	OUT3	4way valve (220-230VAC)
4	OUT4	High speed of fan motor (220-230VAC)
5	OUT5	Low speed of fan motor (220-230VAC)
6	AC-N	Neutral wire
7	NET GND 12V	Wire controller
8	DI01 GND	On/Off Switch(input)(no use)
9	DI02 GND	Flow switch (input)(normal close)
10	DI03 GND	Low pressure protect
11	DI04 GND	High pressure protect
12	DI05 GND	No use
13	DI06 GND	No use
14	AI01 GND	Suction temp.(input)
15	AI02 GND	Water in temp.(input)
16	AI03 GND	Water out temp.(input)
17	AI04 GND	Temp. Of coil (input)
18	AI05 GND	Ambient temp.(input)
19	AI06 GND	No use
20	CN1	Primary transformer
21	CN2	Secondary transformer
22	CN6	Without use
23	CN19	Electronic expansion valve
24	5V CN16 GND	Flow meter

Swimming pool heat pump

2. Wiring diagram

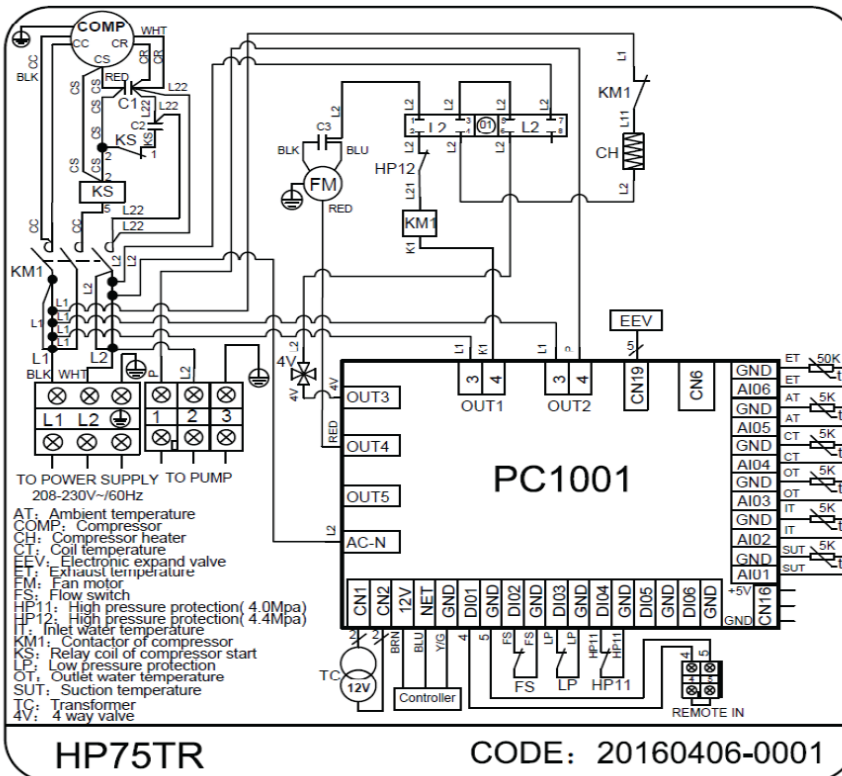
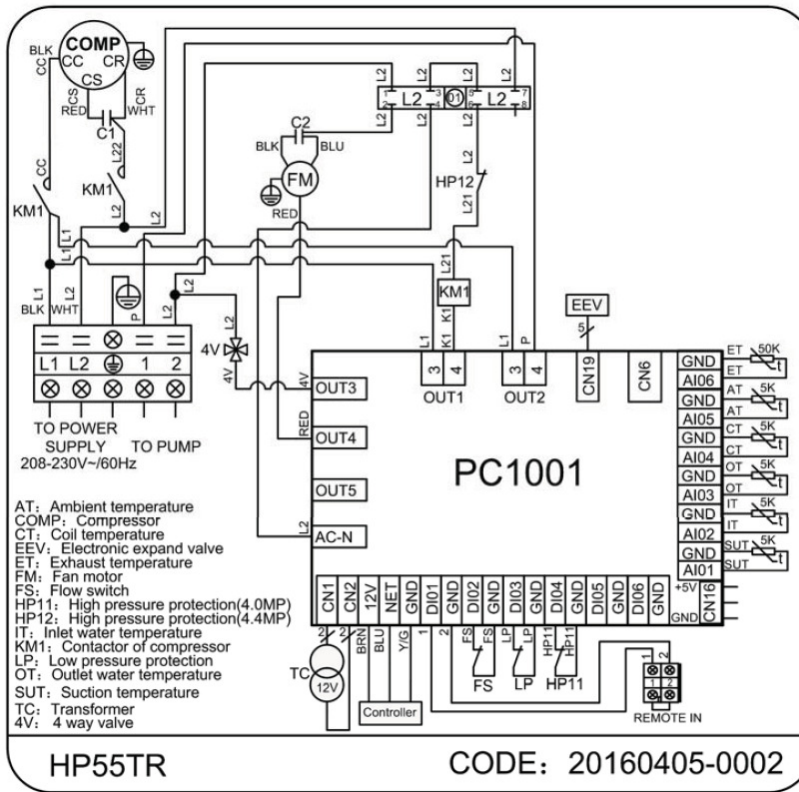

VII. Description of the parameters

D—Defrost parameter

D01—Start defrost temperature

To start the defrost cycle, the condition must be valid for the time d03.

D02—End defrost temperature

Establishes the temperature above which the defrost cycle ends.

D03—Defrosting cycle

Represents delay between two successive defrost cycle. The first time, when coil temperature is lower than D01, there must be valid for the time d03 to start defrost.

D04—Maximum defrosting duration

Represents the maximum duration of the defrost cycle (the defrost ends when the maximum duration has been arrived, even if the unit has not reached the end defrost temperature)

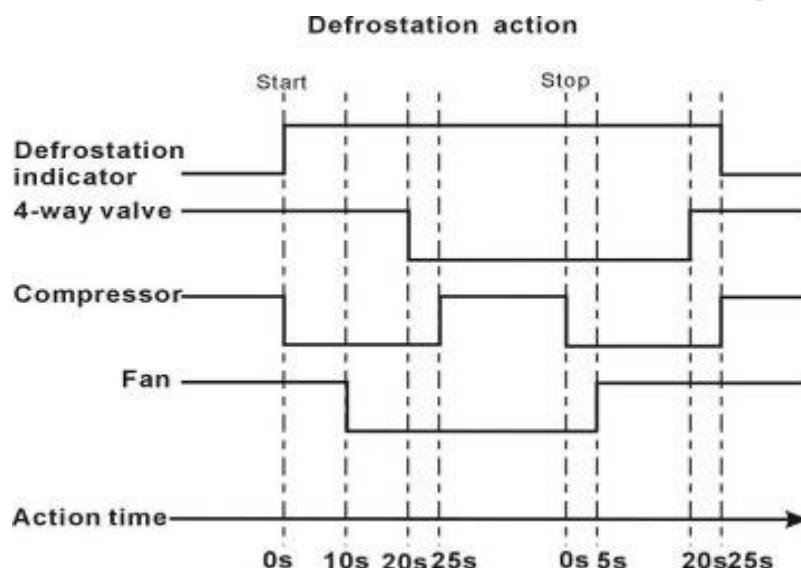

Attention: The situation of defrosting abnormal end

- 1) Shut off the unit during defrosting, system will continue running defrost until it has finished.
- 2) HP switch has broken during defrosting, then unit will be shut off and show HP malfunction. After recovering it, system enters to normal heating mode.
- 3) LP switch has broken during defrosting, the unit will skip LP malfunction and continue working at defrosting mode. After exiting defrosting and back to normal heating mode, the system will check LP switch after 5min.
- 4) Flow switch has broken during defrosting, then unit will be shut off and show Flow malfunction. After recovering this malfunction, system goes on defrosting till the time is up to D04.
- 5) Exhaust temperature is too high during defrosting, then unit will be shut off and show this malfunction. After recovering it, system goes on defrosting till the time is up to D04.

Swimming pool heat pump

- 6) Temperature difference between inlet and outlet is too high during defrosting, then unit will be shut off and show this malfunction. After recovering it, system goes on defrosting till the time is up to D04.
- 7) System show Antifreeze protection during defrosting, then unit will be shut off and show this malfunction. After recovering it, system goes on defrosting till the time is up to D04.

E——EEV parameter

Normally, EEV starts to adjust the opening after the compressor has run 3min. Within the 3 min, the opening of EEV will keep in E03.

E01——EEV mode

E01=0: EEV is running by manual operation;

E01=1: EEV is running by automatic operation;

E02——Target Super heat

E03——Initial position

If E01=0, represents expansive valve fix this position always.

If E01=1, represents expansive valve initiation position.

E04——Minimum position

E05——Defrost position

Fix the EEV position during system is defrosting.

E06——Cooling position

Fix the EEV position during system at cooling mode.

F——Fan parameter

Normally, Fan will start up 10s ahead of Compressor and 30s later to shut off. When defrosting, Fan running situation is according to defrosting control.

F01——Fan parameter

F01=0: in low speed fan mode;

F01=1: in high speed fan mode;

F01=2: the fan running modes depend on coil or ambient temperature (F02-F07);

Attention: The temperature probe is decided by F10.

F01=3: the fan runs at low speed depends on time (F08-F09), the fan runs at high speed during the other time;

F01=4: the fan running speed depends on F02 and F03.

F02——Coil or ambient temperature set point for high speed fan mode (Cooling)

This represents if the temperature above F02, the fan will on high speed (Cooling)

F03——Coil or ambient temperature set point for low speed fan mode (Cooling)

This represents if the temperature below which the fans remain on at low speed (Cooling)

F04——Coil or ambient temperature set point for the fan stop (Cooling)

Swimming pool heat pump

This represents the temperature in reference to F03 below which the fans are stopped.

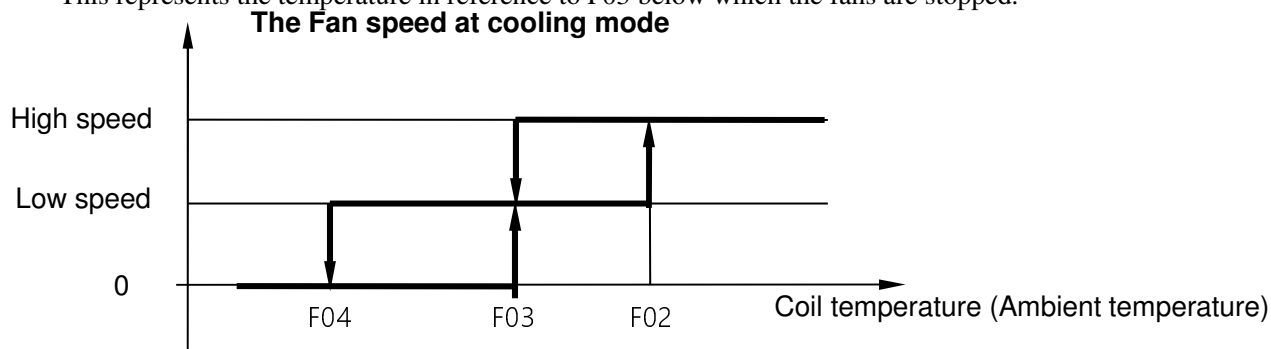

F05—Coil or ambient temperature set point for high speed fan mode (Heating)

This represents the temperature above which the fans remain on at high speed (Heating)

F06—Coil or ambient temperature set point for low speed fan mode (Heating)

This represents the temperature below which the fans remain on at low speed (Heating)

F07—Coil or ambient temperature set point for the fan stop (Heating)

This represents the temperature in reference to F06 below which the fans are stopped.

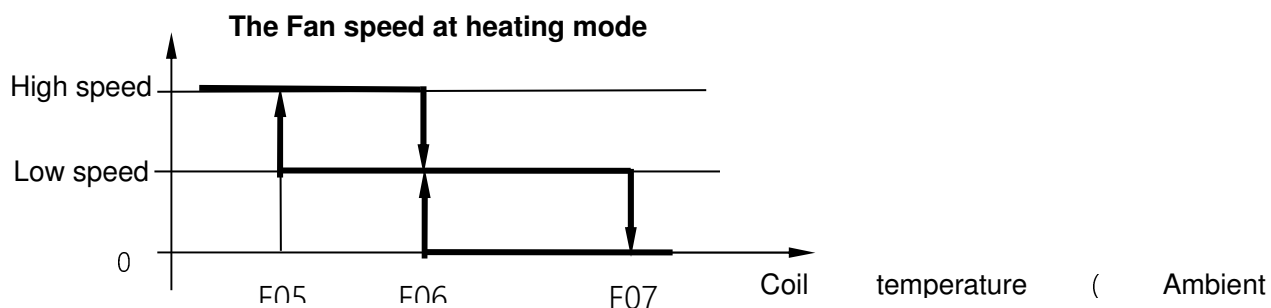

F08—Fan start low speed running time (Just for F01=3)

F09—Fan stop low speed running time (Just for F01=3)

F10—Fan speed control temp.

When F10=0, Fan speed is decided by coil temperature;

When F10=1, Fan speed is decided by ambient temperature.

H—System Parameter

H01—Automatic restart

H01=0: disable automatic restart; H01=1: enable automatic restart

H02—Mode

H02=0: only cooling;

H02=1: heating, cooling and automatic;

H02=2: only heating.

H03—Temperature unit of measure

H03=0: Centigrade unit; (Other area)

H03=1: Fahrenheit unit.(For North America area)

Swimming pool heat pump

P—Water pump parameters

P01—Water pump model

P01=0, water pump will always on except on standby and alarm.

P01=1, water pump will operate depend on compressor, and has 2 minutes delay after the compressor has stopped;

P01=2, water pump will be started and stopped at regular intervals after compressor stop. Depend on P02 and P03.

P02— Minimum off time before the next pump start.

P03— Minimum on time that the pump remains on.

P04—The time of pump advance compressor to start up.

The action sequence of pump and compressor

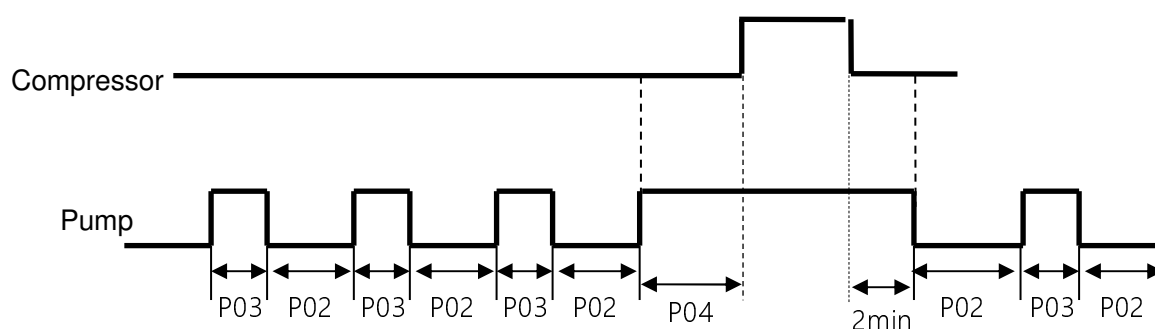

R—Temperature parameter

R01—Cooling set point

Inlet water setting temp. (Cooling)

R02—Heating set point

Inlet water setting temp. (Heating)

R03—AUTO set point (Auto mode)

Target setting temperature for auto mode.

R04—Start differential of cooling

This represents the difference between R01 and start cooling point.

R05—Stop differential of cooling

This represents the difference between R01 and stop cooling point.

Compressor action at cooling mode

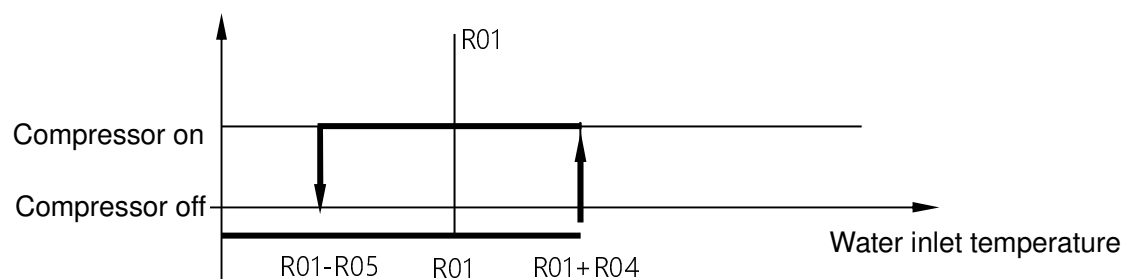

Swimming pool heat pump

R06—Start differential of heating

This represents the difference between R02 and start heating point.

R07—Stop differential of heating

This represents the difference between R02 and stop heating point.

Compressor action at heating mode

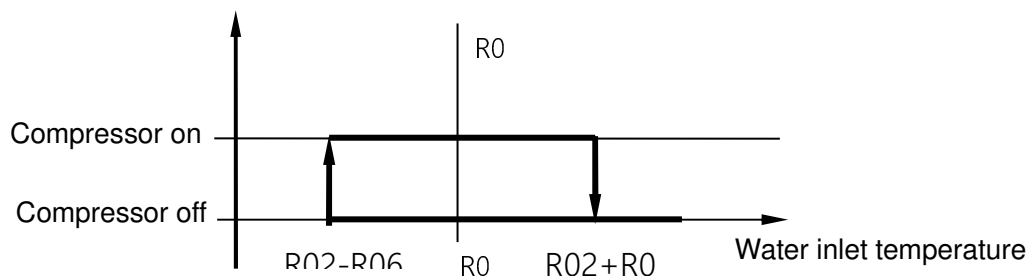

Compressor action at Automatic mode

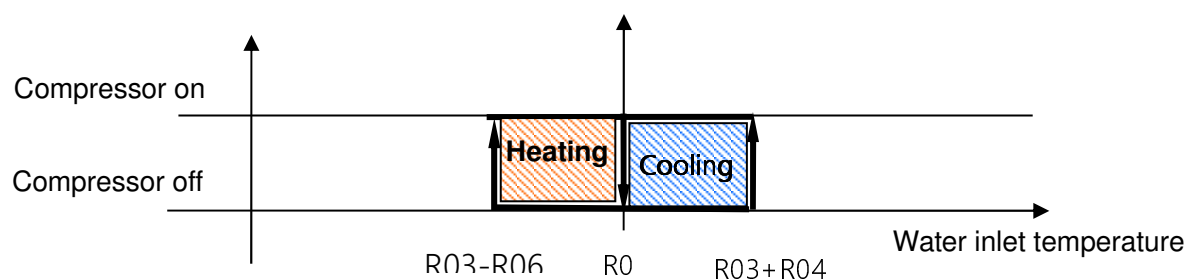

R08—Min. set point in Cooling

Establishes the minimum limit for setting the Cooling set point

R09—Max. Cooling set point

Establishes the maximum limit for setting the Cooling set point

R10—Min. Heating set point

Establishes the minimum limit for setting the Heating set point

R11—Max. Heating set point

Establishes the maximum limit for setting the Heating set point

U—Flow parameter

U02—the pulse number of flow gauge in 1L water

0—Condition of load

001—Compressor output

Whether compressor is switch on or off

002—Circulation water pump output

Whether circulation water pump is switch on or off

003—4- way valve output

Swimming pool heat pump

Whether four way valve output is switch on or off

004——Fan motor high speed output

Whether fan motor high speed output is switch on or off

005——Fan motor low speed output

Whether fan motor low speed output is switch on or off

006——EEV output

The step of EEV ranges from 0-500N

S——Condition of switch

S01——Emergency switch

Whether the emergency switch is switch on or off

S02——Water flow switch

Whether water flow switch is switch on or off

S03——LP switch

Whether LP switch is switch on or off

S04——HP switch

Whether HP switch is switch on or off

T——condition of temperature

T01——Suction temperature

T02——Inlet water temperature

T03——Outlet water temperature

T04——Coil temperature

T05——Ambient temperature

T06——Exhaust temperature

Appendix I

NTC R-T Table (R25=5K Ω B25/50=3470K)

T(°C)	R(K Ω)	T(°C)	R(K Ω)	T(°C)	R(K Ω)
-30.0	63.7306	14.0	7.7643	58.0	1.5636
-29.0	60.3223	15.0	7.4506	59.0	1.5142
-28.0	57.1180	16.0	7.1513	60.0	1.4666
-27.0	54.1043	17.0	6.8658	61.0	1.4206
-26.0	51.2686	18.0	6.5934	62.0	1.3763
-25.0	48.5994	19.0	6.3333	63.0	1.3336
-24.0	46.0860	20.0	6.0850	64.0	1.2923
-23.0	43.7182	21.0	5.8479	65.0	1.2526
-22.0	41.4868	22.0	5.6213	66.0	1.2142
-21.0	39.3832	23.0	5.4048	67.0	1.1771
-20.0	37.3992	24.0	5.1978	68.0	1.1413
-19.0	35.5274	25.0	5.0000	69.0	1.1068
-18.0	33.7607	26.0	4.8108	70.0	1.0734
-17.0	32.0927	27.0	4.6298	71.0	1.0412
-16.0	30.5172	28.0	4.4566	72.0	1.0100
-15.0	29.0286	29.0	4.2909	73.0	0.9800
-14.0	27.6216	30.0	4.1323	74.0	0.9509
-13.0	26.2913	31.0	3.9804	75.0	0.9228
-12.0	25.0330	32.0	3.8349	76.0	0.8957
-11.0	23.8424	33.0	3.6955	77.0	0.8695
-10.0	22.7155	34.0	3.5620	78.0	0.8441
-9.0	21.6486	35.0	3.4340	79.0	0.8196
-8.0	20.6380	36.0	3.3113	80.0	0.7959
-7.0	19.6806	37.0	3.1937	81.0	0.7730
-6.0	18.7732	38.0	3.0809	82.0	0.7508
-5.0	17.9129	39.0	2.9727	83.0	0.7293
-4.0	17.0970	40.0	2.8688	84.0	0.7086
-3.0	16.3230	41.0	2.7692	85.0	0.6885
-2.0	15.5886	42.0	2.6735	86.0	0.6690
-1.0	14.8913	43.0	2.5816	87.0	0.6502
0.0	14.2293	44.0	2.4934	88.0	0.6320
1.0	13.6017	45.0	2.4087	89.0	0.6144
2.0	13.0057	46.0	2.3273	90.0	0.5973
3.0	12.4393	47.0	2.2491	91.0	0.5808
4.0	11.9011	48.0	2.1739	92.0	0.5647
5.0	11.3894	49.0	2.1016	93.0	0.5492
6.0	10.9028	50.0	2.0321	94.0	0.5342

Swimming pool heat pump

7.0	10.4399		51.0	1.9656		95.0	0.5196
8.0	9.9995		52.0	1.9015		96.0	0.5055
9.0	9.5802		53.0	1.8399		97.0	0.4919
10.0	9.1810		54.0	1.7804		98.0	0.4786
11.0	8.8008		55.0	1.7232		99.0	0.4658
12.0	8.4385		56.0	1.6680		100.0	0.4533
13.0	8.0934		57.0	1.6149			

- 1) When there is some malfunction, test resistance value by multimeter, and compare the practical temperature with the above table, then you will know whether this NCT resistance is OK or not.
- 2) Generally, from above table, you can know the temperature by testing NTC resistance value.

PHNIX

Guang Dong PHNIX Eco-energy solution Ltd.