

BOX RLF

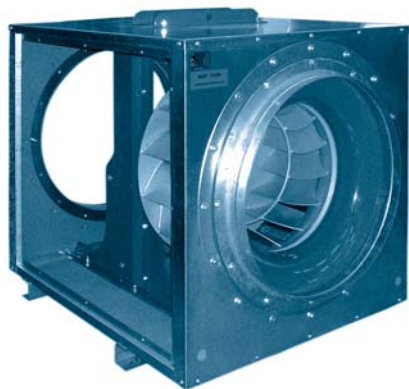

INMERSOS

ACCESORIOS ANCILLARIES ACCESSOIRES ZUBEHÖR



RFS



ASD



INT



PE



BA-400



SIL-C

ES

CARACTERÍSTICAS GENERALES:

Serie compuesta por 9 tipos de caja desde 315 hasta 800, provista de motores de 4, 6 Y 8 polos trifásicos. Caudales desde 2.109 m³/h hasta 32.000 m³/h.
 Temperatura máxima de trabajo 50°C.

CARACTERÍSTICAS CONSTRUCTIVAS:

- Caja construida en chapa de acero galvanizado con aislamiento acústico.
- Bridas circulares a la aspiración y descarga.
- Ventilador centrífugo con rodete de álabes hacia atrás. Motor acoplado directamente al rodete.
- Motor asíncrono normalizado de jaula de ardilla con protección IP-55 y aislamiento clase H HOMOLOGADO PARA 400°C/2H.
- Voltajes Standard 230/400V 50Hz para motores trifásicos hasta 5,5CV y 400/690V 50Hz para potencias superiores.

APLICACIONES:

- Unidades de ventilación 400°C/2h especialmente diseñadas para trabajar **INMERSAS** en la zona de riesgo de incendio.
- Extracción de humos, aire, etc en aplicaciones donde principalmente se requiera el sentido lineal de circulación de aire entre aspiración e impulsión.

BAJO DEMANDA:

- Ventiladores para trabajar a 60Hz, voltajes especiales...

EN

GENERAL FEATURES:

Range with 9 different sizes from 315 until 800, provided with three phase 4, 6 and 8 pole motors. Air-flow from 2.109 m³/h until 32.000 m³/h. Maximum working temperature 50°C in continuous.

MANUFACTURING FEATURES:

- Box manufactured in galvanised steel sheet with soundproofing. Easy motor access and fan maintenance through removable panels.
- High efficiency single inlet backward curved impeller, manufactured of rolled steel sheet and epoxy powder finishing.
- Squirrel cage asynchronous standard motor, IP-55 protection and rated class H insulation CERTIFIED 400°C/2H. Standard voltages 230/400V 50Hz for three phase, motors up to 5.5HP and 400/690V 50Hz for higher powers.

APPLICATIONS:

- Designed to work in linear system of air circulation between aspiration and impulsion.
- Smoke emergency exhaust fans with the **MOTOR INSIDE THE HAZARDOUS AREA** and where high pressures are needed.

UNDER REQUEST:

- 60Hz fans and special voltages.

FR

CARACTERISTIQUES GÉNÉRALES:

Série composte par 9 modèles de la taille 315 à 800. Moteurs de 4, 6 et 8 pôles monophasés et triphasés. Débits de 2.109 m³/h à 32.000 m³/h. Température maximale de l'air 50°C.

CARACTÉRISTIQUES DE FABRICATION:

- Caisson construit en tôle d'acier galvanisé avec isolant acoustique.
- Piquages ronds à l'aspiration et au refoulement.
- Turbine de pales inclinées vers l'arrière.
- Entraînement direct.
- Moteur asynchrone normalisé à cage d'écureuil degré de protection IP-55 et isolation électrique classe H, HOMOLOGUÉ 400°C/2H. Tensions Standard 230V 50Hz pour moteurs monophasés. 230/400V 50Hz pour moteurs triphasés jusqu'à 5,5CV et 400/690V pour puissances supérieures.

APPLICATIONS:

- Conçus pour installation en ligne.
- Désenfumage en cas d'incendie, ventilateur installé **DANS LA ZONE DE RISQUE**.

OPTIONS DISPONIBLES:

- Ventilateurs pour travailler à 60Hz, tensions spéciales.

DE

ALLGEMEINE MERKMALE:

Baureihe bestehend aus 9 Gehäusetypen, von 315 bis 800, ausgestattet mit 4, 6- und 8-poligen Dreiphasenmotoren. Luftfördermengen von 2.109 m³/h bis 32.000 m³/h. Maximale Arbeitstemperatur 50 °C.

BAULICHE MERKMALE:

- Gehäusekasten aus verzinktem Stahlblech mit Schallisolierung.
- Rundflansche an Ansaugung und Ablass.
- Radialventilator mit nach hinten geneigtem Schaufelrad.
- Motor direkt an das Laufrad gekoppelt.
- Standardisierter Asynchron-Käfigläufermotor mit Schutzart IP-55 und Isolierklasse F.
- Spannungen von 230/400 V, 50 Hz, für Dreiphasenmotoren bis 5,5 PS und 400/690 V, 50 Hz, für höhere Leistungsbereiche.

ANWENDUNGEN:

- Lüftungseinheiten für 400 °C/2 h, die speziell für den Betrieb **INNERHALB** von Bereichen mit Brandgefahr entwickelt wurden.
- Rauchgasabsaugung, Luftabsaugung usw. für Anwendungen, bei denen vor allem ein Betrieb mit linearer Luftzirkulation zwischen Saug- und Druckseite erforderlich ist.

AUF ANFRAGE:

- Lüfter, die mit 60 Hz, besonderen Spannungen usw. arbeiten.

BOX RLF

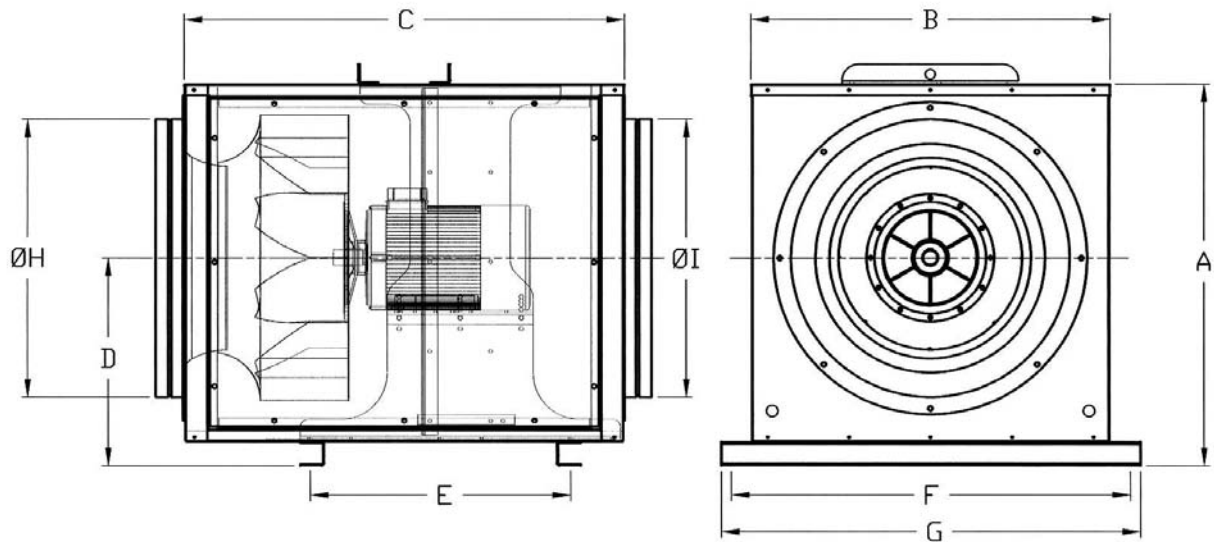

DIMENSIONES / DIMENSIONS / ENCOMBREMENT / ABMESSUNGEN (mm)

Model	Caja	A	B	C	D	E	F	G	Ø H	Ø I
BOX RLF 315	700x700x900	760	700	900	380	450	800	850	298	298
BOX RLF 355	700x700x900	760	700	900	380	450	800	850	348	348
BOX RLF 400/L	700x700x900	760	700	900	380	450	800	850	398	398
BOX RLF 400/H	800x800x1000	860	800	1000	459	550	900	950	398	398
BOX RLF 450	800x800x1000	860	800	1000	459	550	900	950	448	448
BOX RLF 500	800x800x1000	860	800	1000	459	550	900	950	498	498
BOX RLF 560/L	800x800x1000	860	800	1000	459	550	900	950	548	548
BOX RLF 560/H	900x900x1100	960	900	1100	522	650	1000	1050	548	548
BOX RLF 630	900x900x1100	960	900	1100	522	650	1000	1050	628	628
BOX RLF 710/L	900x900x1100	960	900	1100	522	650	1000	1050	698	698
BOX RLF 710/H	1050x1050x1200	1110	1050	1200	590	650	1150	1200	698	698
BOX RLF 800	1050x1050x1200	1110	1050	1200	590	650	1150	1200	798	798

BOX RLF

SERIE TRIFÁSICA / THREE PHASE / SÉRIE TRIPHASÉE / DREIPHASIG

Model	R.P.M max.	I max. (A)			Kw	m³/h	dB (A)
		230	400	690			
BOX RLF 315 T2 1,5	2.820	5,01	2,9	-	1,1	4.218	67
BOX RLF 355 T2 3	2.860	8,2	4,7	-	2,2	5.800	69
BOX RLF 400 T2/L 4	2.800	12,48	7,21	-	3	8.100	73
BOX RLF 400 T2/H 4	2.800	12,48	7,21	-	3	8.100	76
BOX RLF 315 T4 3/4	1.400	2,8	1,6	-	3	2.109	79
BOX RLF 355 T4 3/4	1.400	2,8	1,6	-	3	2.800	54
BOX RLF 400 T4/L 1	1.400	3,74	2,16	-	0,75	3.950	52
BOX RLF 400 T4/H 1	1.400	3,74	2,16	-	0,75	3.950	61
BOX RLF 450 T4 1,5	1.400	4,87	2,81	-	1,1	5.971	62
BOX RLF 500 T4 2	1.420	6,32	3,65	-	1,5	8.250	64
BOX RLF 560 T4/L 4	1.410	11,53	6,66	-	3	12.275	66
BOX RLF 560 T4/H 4	1.410	11,53	6,66	-	3	12.275	68
BOX RLF 630 T4 7,5	1.450	-	13,14	7,3	5,5	16.300	69
BOX RLF 710 T4/L 10	1.420	-	16,5	9,5	7,5	23.623	71
BOX RLF 710 T4/H 10	1.420	-	16,5	9,5	7,5	23.623	72
BOX RLF 800 T4 20	1.430	-	30,59	17,68	15	32.000	75
BOX RLF 500 T6 1	910	4,1	2,4	-	0,75	5.400	54
BOX RLF 560 T6/L 2	930	7,2	4,2	-	1,5	8.150	56
BOX RLF 560 T6/H 2	930	7,2	4,2	-	1,5	8.150	57
BOX RLF 630 T6 2	930	7,2	4,2	-	1,5	10.760	59
BOX RLF 710 T6/L 4	955	12,1	7	-	3	15.700	63
BOX RLF 710 T6/H 4	955	12,1	7	-	3	15.700	65
BOX RLF 800 T6 4	955	12,1	7	-	3	24.800	66
BOX RLF 630 T8 1,5	695	6,4	4,7	-	1,1	8.060	59
BOX RLF 710 T8/L 2	710	5,9	4,4	-	1,5	11.775	60
BOX RLF 800 T8 3	720	8,8	6,5	-	2,2	19.500	62

SERIE TRIFÁSICA 2 VELOCIDADES / THREE PHASE 2 SPEEDS / SÉRIE TRIPHASÉE DEUX VITESSES / DREIPHASIG 2G

Model	R.P.M max.	400 V Dahlander (A)			Kw	m³/h	dB (A)
		3000	1500	750			
BOX RLF 315 T2/T4 1,29-0,33	2.780/1.385	2,4	0,61	-	0,95/0,25	4.218/2.109	69/51
BOX RLF 355 T2/T4 2,72-0,68	2.835/1.420	3,5	0,76	-	1,4/0,33	5.800/2.900	72/53
BOX RLF 400/H T2/T4 4,2-1,09	2.885/1.445	10,7	2,5	-	4,4/1,1	8.100/4.050	80/57
BOX RLF 355 T4/T8 0,68-0,14	1.375/680	-	1,28	0,57	0,5/0,1	2.800/1.400	58/47
BOX RLF 400/H T4/T8 0,95-0,2	1.380/685	-	1,76	0,77	0,7/0,15	3.950/2.000	61/49
BOX RLF 450 T4/T8 1,36-0,3	1.370/695	-	2,4	1,25	1/0,22	5.971/2.980	64/51
BOX RLF 500 T4/T8 2-0,48	1.375/700	-	3,3	1,8	1,5/0,33	8.250/4.125	66/53
BOX RLF 560/H T4/T8 3,4-0,88	1.400/700	-	5,3	2,8	2,5/0,65	12.275/6.150	68/54
BOX RLF 630 T4/T8 6,4-1,5	1.455/720	-	10,3	3,3	4,7/1,1	16.300/8.150	71/57
BOX RLF 710/H T4/T8 8,7-1,9	1.455/720	-	13,3	4,4	6,4/1,4	23.623/11.810	73/59
BOX RLF 800 T4/T8 19-4,5	1.470/730	-	28,6	9,3	14/3,3	32.000/16.000	77/62

NOTA: CONSULTAR CURVAS BOX RL. PÁG. 51-53
 NOTE: LOOK AT BOX RL PERFORMANCE CURVES. PAGES 51-53

BOX RL
BOX RLF
BOX RLFX

BOX RL/BOX RLF T2

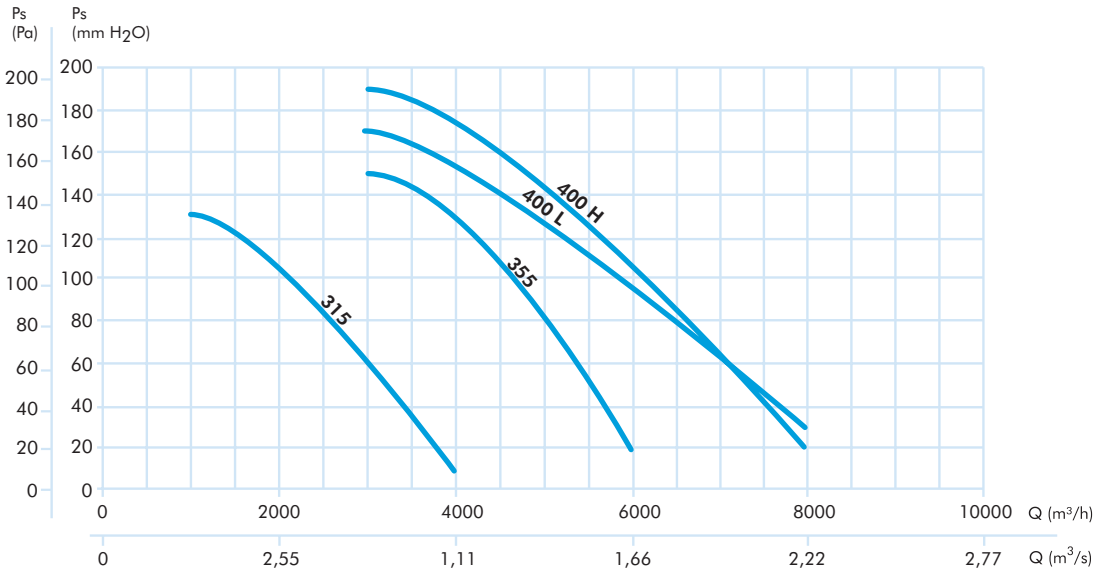

BOX RL/BOX RLF T4

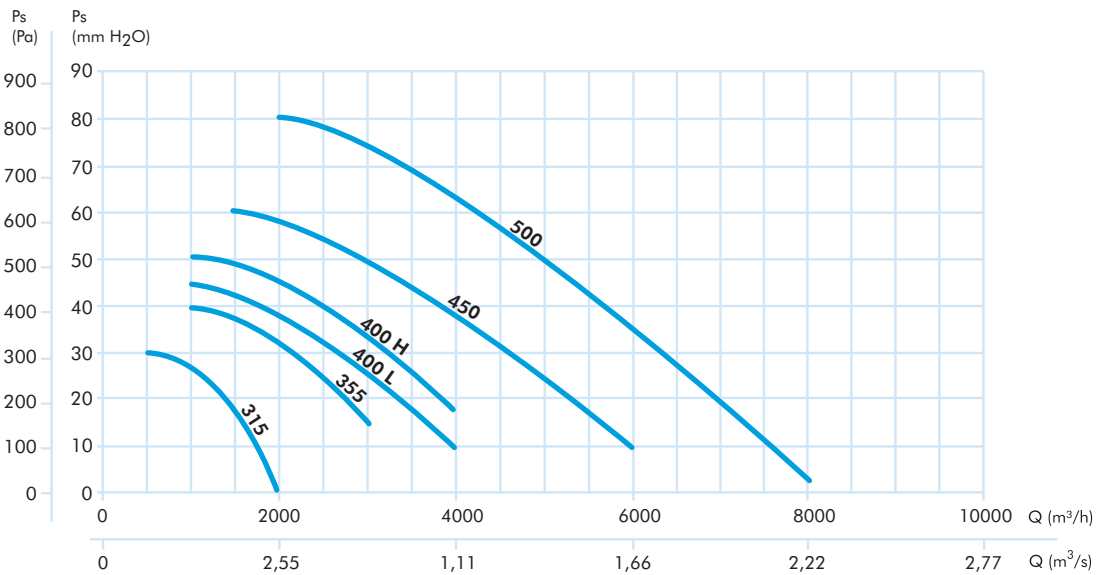

BOX RL
BOX RLF
BOX RLFX

BOX RL/BOX RLF T4

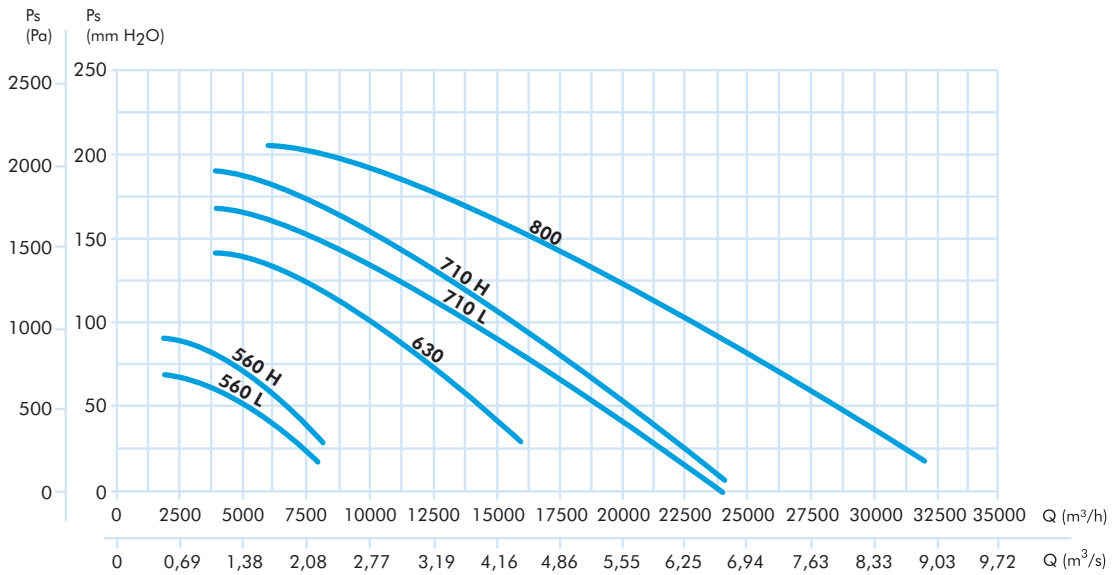

BOX RL/BOX RLF T6

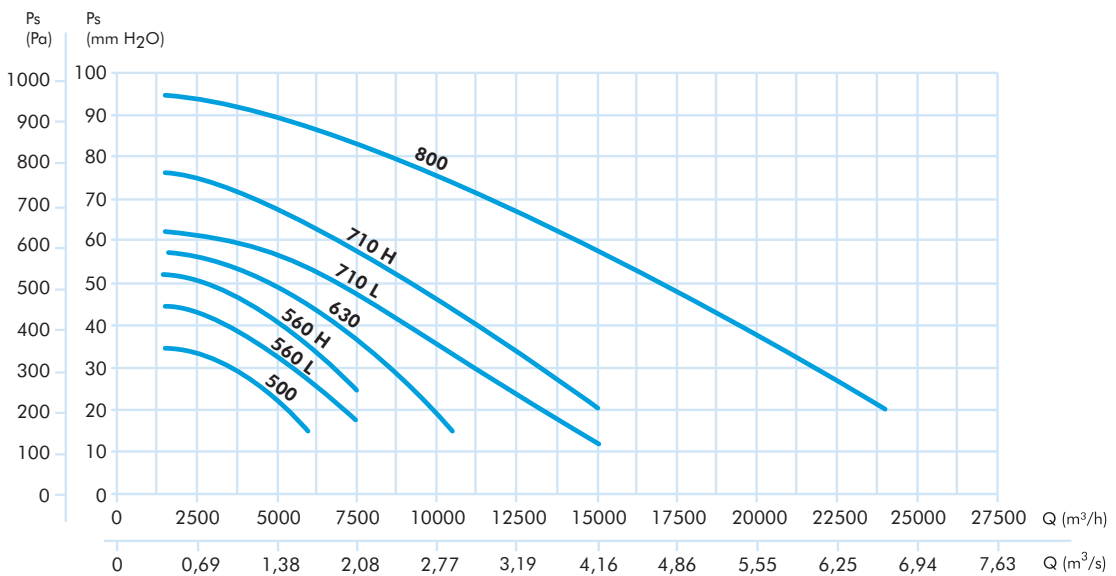

BOX RL
BOX RLF
BOX RLFX

BOX RL/BOX RLF T8

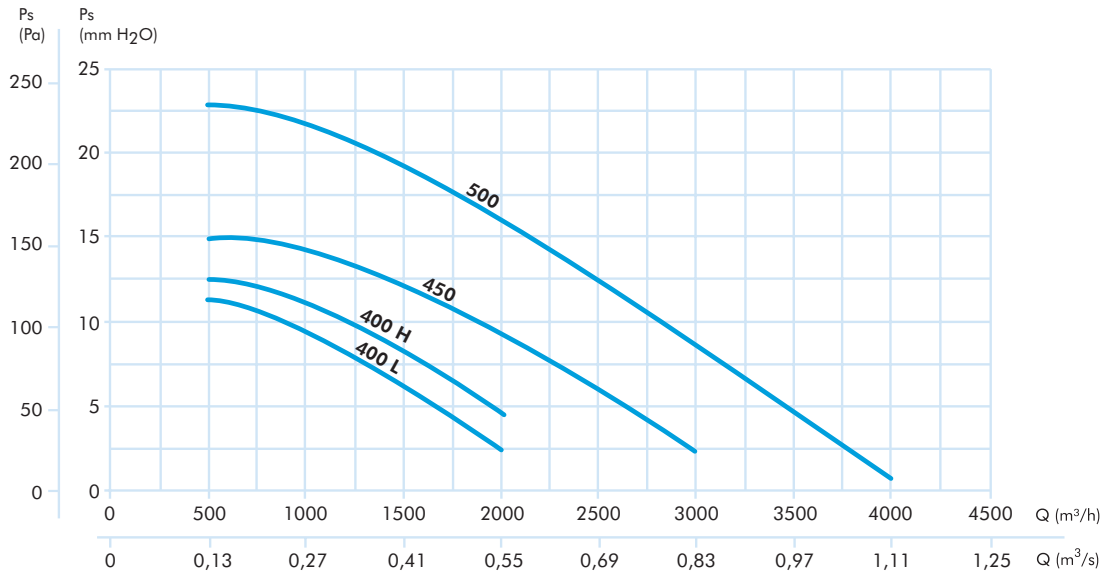

BOX RL/BOX RLF T8

